

NEW ZEALAND  
ELECTRICAL CODE OF PRACTICE  
FOR  
REPAIR AND MAINTENANCE OF  
DOMESTIC ELECTRICAL APPLIANCES  
BY THE OWNER OF THE APPLIANCE

Issued by:  
Deputy Secretary  
Energy Safety Service  
Wellington, New Zealand

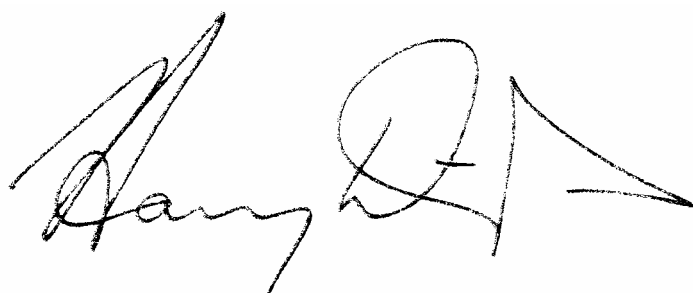
## THE ELECTRICITY ACT 1992

### **Approval of the New Zealand Electrical Code of Practice for Repair and Maintenance of Domestic Electrical Appliances by the Owner of the Appliance 2004 (NZECP 50:2004) and the Revocation of the New Zealand Electrical Code of Practice for Repair of Domestic Electrical Equipment (NZECP 50:1993)**

Pursuant to section 38 of the Electricity Act 1992, I hereby approve the New Zealand Electrical Code of Practice for Repair and Maintenance of Domestic Electrical Appliances by the Owner of the Appliance 2004 (NZECP 50:2004) and the Revocation of the New Zealand Electrical Code of Practice for Repair of Domestic Electrical Equipment (NZECP 50:1993).

The New Zealand Electrical Code of Practice for Repair and Maintenance of Domestic Electrical Appliances by the Owner of the Appliance 2004 (NZECP 50:2004) and the Revocation of the New Zealand Electrical Code of Practice for Repair of Domestic Electrical Equipment (NZECP 50:1993) was issued by the Deputy Secretary, Energy Safety Service, acting under delegated authority (*pursuant to section 41 of the State Sector Act 1988*) from the Chief Executive, Ministry of Economic Development on the 17<sup>th</sup> day of June 2004.

Dated this 27<sup>th</sup> day of July 2004.

A handwritten signature in black ink, appearing to read 'Gary R. [unclear]', written in a cursive style.

Associate Minister of Energy

## **COMMITTEE REPRESENTATION**

This Code of Practice was prepared by the Energy Safety Service, Ministry of Consumer Affairs, in consultation with the following:

Electrical Contractors Association of New Zealand

Electricity Engineers' Association of New Zealand Inc

Institution of Professional Engineers New Zealand

Standards New Zealand

Appliance & Electronic Industry Association

New Zealand Electrical Institute

Building Industry Authority of New Zealand

Electrical Workers Registration Board

Electrical Safety Organisation

National Council of Women of New Zealand

New Zealand Council of Elders

Consumers Institute

## **REVIEW**

This Code of Practice will be revised as occasions arise. Suggestions for improvements of this Code are welcome. They should be sent to ECP 50, Energy Safety Service, Ministry of Consumer Affairs, PO Box 1473, WELLINGTON.

## FOREWORD

Are you competent to be able to carry out the electrical work to which this code applies? To increase your skills in electrical work, there are training courses available at your local polytechnic or through your Community educational services or Marae. You are **ONLY** permitted to carry out work on 230 volt, 10 amp AC single-phase domestic electrical appliances, cord sets or extension leads.

The following extracts from the Electricity Act 1992 and Electricity Regulations 1997 are applicable to the maintenance of electrical appliances.

To obtain copies of the relevant legislation, see the website: [www.legislation.govt.nz](http://www.legislation.govt.nz)

### **Electricity Act section 169 Clause 20 only shown**

**169. Regulations** – (1) The Governor-General may from time to time, by Order in Council, make regulations for all or any of the following purposes:

(20) Prescribing the limits or scope of prescribed electrical work which any of the persons referred to in section 108 (2) of this Act, or any person to whom section 109 or section 110 or section 111 or section 112 of this Act applies, may do or assist to do:

### **Electricity Act section 111**

**111. Exemption for maintenance of domestic appliances** – (1) Notwithstanding anything in section 108 of this Act, the owner of any electrical appliance may do any prescribed electrical work, or assist in doing any prescribed electrical work, in relation to that appliance, if–

- (a) The appliance is kept principally for the use of that person, or any near relative of that person, or both; and
- (b) The appliance is used principally for domestic purposes and not for commercial or industrial purposes; and
- (c) The work is within the limits prescribed in regulations made under section 169 of this Act for the purposes of this section; and
- (d) The work is carried out in accordance with the requirements of any regulations made under section 169 of this Act; and
- (e) The work is carried out in a competent manner; and
- (f) While that work is being carried out, the appliance is not connected to a power supply; and

- (g) Where required by regulations made under section 169 of this Act, the work is tested and certified by a registered electrical inspector in accordance with regulations made under that section before connection to a power supply.
- (2) For the purposes of subsection (1) of this section, the term “near relative”, in relation to any person, means—
  - (a) A grandparent of that person:
  - (b) A parent (*including a step-parent*) of that person:
  - (c) A parent (*including a step-parent*) of that person's spouse:
  - (d) A brother or sister of that person, including a half-brother or half-sister:
  - (e) That person's spouse, which for the purposes of this section includes any person (*including a person who is of the same gender as the first-mentioned person*) with whom the first-mentioned person is living in a relationship in the nature of marriage although those persons are not legally married to each other:
  - (f) A child (*including a stepchild*) of that person:
  - (g) A child (*including a stepchild*) of that person's spouse:
  - (h) A grandchild of that person.

## **Electricity Regulation 17 (2)(n)**

### **17. Prescribed electrical work**

(2) The following work is deemed not to be prescribed electrical work:

- (n) Work done on low voltage fittings, where—
  - (i) The work consists of—
    - (A) The replacement of a fuse link with a fuse link or plug-in miniature circuit-breaker of appropriate rating; or
    - (B) Affixing a fitting (*being a plug, an adaptor, a cord extension socket, or an appliance connector*) of an appropriate rating to a flexible cord that is designed to have such a fitting affixed to it; and
  - (ii) There is in force in respect of the work a standard set by the Secretary for the purpose; and
  - (iii) The work is done in a competent manner, without payment or reward, and in accordance with that standard.

For the purposes of Regulation 17 (2)(n), section 3 and Appendix A of this code are deemed to meet the Secretary's requirements.

## Electricity Regulation 48

### 48. Maintenance of domestic appliances

For the purposes of section 111 of the Act, the owner of any electrical appliance may do any prescribed electrical work, or assist in doing any prescribed electrical work, in relation to that appliance, provided that the work is carried out in accordance with the requirements of ECP 50.

### Requirements for appliances used in New Zealand

In New Zealand all electrical appliances must include a nameplate identifying its voltage ( $V$ ), and either its current ( $I$ ) or wattage ( $W$ ), and indicate whether the appliance is double insulated. If the appliance is double insulated it will show the symbol, a square box within a square box, see Figure 1 (Page 7). The nameplate may also contain other information relevant to the appliance.

Typical information that could be found on a Nameplate:

Volts or voltage ( $V$ )	= 230 V
Current ( $I$ )	= 4.4 A
Wattage ( $W$ )	= 1000 W
Double insulation	= square box within a square box

There are two types of electrical appliance in New Zealand:

Earthed electrical appliances (*These types of electrical appliances are called Class I appliances*).

These types of electrical appliances have a connection to earth, which means that any exposed metal of the appliance is connected to earth (*e.g. toaster, electric iron etc*). They have a power supply cord with 3-wires, brown, blue and green/yellow, and are fitted with a 3-pin plug.

Double insulated electrical appliances (*These types of electrical appliances are called Class II appliances*).

These types of electrical appliances will **NOT** have any connection to earth. This means that the exposed metal (*e.g. electric drill*) has a physical barrier between any metal and the electrical components. They have a power supply cord with 2-wires, brown and blue, and are fitted with a 2-pin plug.

If a 3-wire flexible cord is used on a double insulated electrical appliance, the green/yellow wire **MUST** be connected at the plug but must **NOT** be connected to any part of the double insulated appliance. The green/yellow wire must be cut back to the outer insulation of the flexible cord (*see section 4 for further details*).

### **Colour coding of wires for flexible cords**

The colour coding of the wires for **NEW** flexible cords will be:

Brown = Active (Phase), symbol A, P or L

Blue = Neutral, symbol N

Green/yellow = Earth, symbol E

The colour coding of the wires for **OLD** flexible cords will be:

Red = Active (Phase), symbol A or P

Black = Neutral, symbol N

Green = Earth, symbol E

### **Maori terms**

From a Maori perspective, the term “earth” or Papatuanuku translates as Earth Mother – the source of all energy. When aligning this concept to the flow of electricity, a useful parallel can be made to the 3-pin plug.

Electricity	Maori
Active ( <i>phase</i> )	Spiritual element, active, tapu
Neutral	Physical element, neutral, noa
Earth	Mauri or life force derived from Papatuanuku or Earth Mother

For the purposes of regulation 17(2)(n), for payment or reward also means koha.

# CONTENTS

FOREWORD	iv
OUTLINE	1
Section 1: Introduction	1
1.1 General	1
1.2 Definitions	3
1.3 Before you start	6
1.4 Tools	7
1.5 Repairs and Testing	8
1.6 For your own and everyone else's safety	10
Section 2: Flexible Cords and Fittings	12
2.1 Choosing the right parts	12
2.2 Choosing the right flexible cord	13
2.3 Choosing the right plug, socket or appliance connector	15
Section 3: How to Repair Electrical Appliance Power Supply Cords, Cord Sets and Extension Leads	16
3.1 Safety procedures	16
3.2 Preparing a flexible cord	16
3.3 Attaching a 3-pin plug or socket to a flexible cord	19
3.4 Attaching the appliance connector to a flexible cord	21
3.5 Specific requirements for extension leads	25
3.6 Replacing a power supply cord on an electrical appliance	25
3.7 Testing cords and extension leads	27
Section 4: Repairing Electrical Appliances	30
4.1 General	30
4.2 Double insulated electrical appliances	30
4.3 Permanently connected electrical appliances	31
4.4 Repairing electrical appliances	32
4.5 Testing	33
4.6 Procedure for testing earthed electrical appliances ( <i>Class I</i> )	34
4.7 Procedure for testing double insulated electrical appliances ( <i>Class II</i> )	37
Appendix A: RCDs, Fuses and Circuit-Breakers	38
A1 Residual current devices ( <i>RCDs</i> )	38
A2 Fuses and circuit-breakers	39
A3 Replacing or repairing a ruptured or blown fuse	45



A4	Procedure for testing cartridge fuses	46
A5	Replacing re-wireable fuses with plug-in circuit-breakers	48
Appendix B: Electrical Safety Checks		51
B1	Stay safe	51
B2	Socket-outlets	51
B3	Heating appliances	52
B4	Light fittings	52
B5	RCDs	52
B6	Electrical appliances	53

## TABLES

Table 1:	Colour coding of flexible cord wires	12
Table 2:	Minimum wire size ( <i>for flexible cords</i> )	14
Table 3:	Maximum length of flexible cord for extension leads	15
Table 4:	Circuits and current ratings of fuses or circuit-breakers	40
Table 5:	Fuse/circuit-breaker sizes	48

## FIGURES

Figure 1:	Double Insulation Symbol	7
Figure 2:	Electrical Appliance, Socket-Outlet, Permanent Connection Unit, Cord Sets and Extension Lead	9
Figure 3:	Types and Colour Coding of Wires for New Flexible Cords	12
Figure 3A:	Types and Colour Coding of Older Flexible Cords	13
Figure 4:	Wire with Insulation Removed	18
Figure 5:	Wire with Loop	18
Figure 6:	Wire Doubled Over	18
Figure 7:	3-Pin Plug ( <i>front view</i> )	20
Figure 8:	3-Pin Plug with Cover Removed ( <i>back view</i> )	20
Figure 9:	3-Pin Socket ( <i>front view</i> )	21
Figure 10:	3-pin Socket with Cover Removed ( <i>front and back view</i> )	21
Figure 11:	Appliance Connector ( <i>Old</i> )	24
Figure 11A:	Appliance Connector ( <i>New</i> )	24
Figure 12:	Permanent Connection Unit Wiring	26
Figure 13:	Meter Calibration Test	27
Figure 14:	Active/Neutral to Earth Test	28
Figure 15:	Active or Neutral Test	29
Figure 16:	Earth Test	29
Figure 17:	Earth Test for Electrical Appliances	34

Figure 18:	Active to Earth Test for Electrical Appliances	35
Figure 19:	Neutral to Earth Test for Electrical Appliances	36
Figure 20:	Exposed Metal Test for Double Insulated Electrical Appliances	37
Figure 21:	Types of Fuses	43
Figure 22:	Other Types of Re-wireable Fuses	44
Figure 23:	Testing Cartridge Fuses	47
Figure 24:	Replacement of Fuses with Plug-in Circuit-Breakers	50

# OUTLINE

If you carry out work in accordance with this Code, you are considered to have met the requirements of the Electricity Act and Regulations set out in the Foreword.

To increase your skills in electrical work, courses are available from your local polytechnic or Community educational services or Marae.

Electrical work **MUST** be limited to the repairs or maintenance on your 230 volt (V), 10 amp (A) AC single-phase domestic electrical appliance, cord set or extension lead.

Before you carry out electrical repairs or maintenance on domestic electrical appliances, cord sets or extension leads, you need to read sections 1 – 2. The details for carrying out any repairs or maintenance are set out in sections 3 – 4.

## Section 1: INTRODUCTION

### 1.1 GENERAL

#### 1.1.1 **DO NOT attempt to carry out repairs or maintenance on:**

- (a) 110 V electrical appliances using this code. 110 V electrical appliances **MUST** not be used as they are not designed for use with the electricity supply in New Zealand. If these electrical appliances are connected to the 230 V electricity supply, the appliance may become damaged or cause an electrical hazard.
- (b) 230 V electronic appliances. There are electrical hazards associated with these (*i.e. television sets, radio and audio, micro-waves and computers, etc*) that are outside the scope of this Code. Only licensed electrical workers should carry out repairs to electronic appliances that have a 230 V power supply. The main reason that appliance owners cannot carry out this type of work themselves is that the appliance, when opened,

contains parts that have very high dangerous voltages (e.g. 15,000 V DC).


- (c) Electrical appliances with a current rating in excess of 10 A, 2,300 W.
  - (d) Electrical appliances under warranty, as this will make the warranty invalid. The warranty card should tell you what action needs to be taken. The Consumer Guarantees Act also provides protection for consumers purchasing faulty goods.
  - (e) Electrical appliances that fall under the categories of paragraphs (a) and (b) of clause 1.1.5.
- 1.1.2 This Code does not outline the detailed requirements for the repair of individual electrical appliances.
- 1.1.3 This Code outlines the basic requirements for ensuring work is carried out safely, and includes the testing of electrical appliances, cords, and extension leads before re-using them. This Code aims to ensure that there will be no electrical hazard created after the electrical appliance, cord, or extension lead has been repaired.
- 1.1.4 If you are the owner of a domestic electrical appliance, cord set, or extension lead that is for your own private use, then you are permitted to carry out repairs and maintenance on that appliance, cord set or extension lead in accordance with this Code. This Code applies to single-phase appliances or plugs, sockets or appliance connectors (*fittings*) that are labelled in the range from 220 volts (V) to 250 V.
- 1.1.5 For all new electrical appliances, you will need to follow the manufacturer's recommendation on whether or not it is designed to be repaired. Recently made electrical appliances fall into three categories:
- (a) non-repairable (*do not attempt any repairs on this appliance*);
  - (b) no supply cord replacement (*do not attempt to repair the supply cord*); or
  - (c) full repair can be carried out.
- 1.1.6 If the electrical appliance is repairable and falls under 1.1.5 (c) above and manufacturer's instructions are available to carry out any of the repair work, follow those instructions and the appropriate requirements of this Code.

- 1.1.7 This Code includes advice on how to repair a rewireable fuse link or replace a cartridge fuse, and how to replace a fuse carrier with a plug-in circuit-breaker. It covers the correct procedures for resetting a circuit-breaker or a residual current device (*RCD*) and gives the time frame for regularly testing RCDs, see Appendix A.
- 1.1.8 This Code also provides some basic electrical safety tips in and around your home, see Appendix B.

## 1.2 DEFINITIONS

AC	Alternating current, e.g. your electrical installation uses AC.
Active ( <i>Phase or Live</i> ) ( <i>symbols A, P or L</i> ) Colours: Brown or Red	Any wire used to conduct electricity that is maintained at a different voltage from the neutral or earth wires.
Ampere	The unit of electric current. Current flow is usually expressed as “Amps” or “A”.
Appliance Connector	A fitting attached to a flexible cord and designed to allow the easy connection and disconnection of the cord from the electrical appliance, see Figure 2 ( <i>Page 9</i> ).
Circuit	Wires arranged for the purpose of carrying an electric current.
Circuit-breaker	A device designed to automatically disconnect the power supply in the event of an overload or fault. This can also be manually operated as a switch to disconnect a circuit. Circuit-breakers are different to residual current devices in that they will not protect you from receiving an electric shock.
Cord set	A flexible cord fitted with a plug at one end and a cord connector at the other; for an appliance cord, see Figure 2 ( <i>Page 9</i> ).
Current rating	The current in Amperes ( <i>A</i> ) marked on the nameplate of an electrical appliance.
DC	Direct current, e.g. a torch or portable radio uses direct current from a battery.

Double insulated electrical appliance	An appliance that has no earth connection. This will have the symbol of a square box within a square box or the words “double insulated” marked on the nameplate of the appliance, see Figure 1 ( <i>Page 7</i> ). Known as a Class II electrical appliance.
Earth ( <i>E</i> ) Colours: Green or green/yellow	A connection to the general mass of earth.
Earthed electrical appliance	An appliance that has exposed metal connected to earth. Known as a Class I electrical appliance.
Electrical appliance	An appliance that needs electricity to work.
Extension lead	A flexible cord that has a plug on one end and a socket on the other end see Figure 2 ( <i>Page 9</i> ).
Fitting	Everything used, or designed or intended for use, in or in connection with the generation, conversion, transformation, conveyance, or use of electricity, e.g. socket-outlet, plug, socket etc.
Flexible cord	A cable that is designed to be flexed frequently and connects an electrical appliance to the electrical installation, normally by a plug. See Table 1 ( <i>Page 12</i> ) for colour coding of flexible cords and Figures 3 and 3A ( <i>Pages 12 and 13</i> ) for types of flexible cords.
Fuse ( <i>Rewireable</i> )	A device that disconnects a circuit from a power supply by means of a wire designed to melt when a high electric current flows.
Multi-meter	An electrical test instrument designed to measure various quantities of an electrical circuit. The instrument should be one that measures voltage ( <i>V</i> ), amperage ( <i>A</i> ) AC and DC, and resistance ( <i>ohms</i> ( $\Omega$ )).
Neutral ( <i>N</i> ) Colours: Blue or Black	The return wire of an AC electrical circuit.

Permanent connection unit	A fitting designed for a permanent connection between electrical installation wires and a power supply cord, see Figure 2 ( <i>Page 9</i> ). This fitting is used for fixed wired appliances, such as storage heaters and heated towel rails.
Plug	A fitting designed to be attached to a flexible cord, which has exposed pins, arranged to enter and fit into a socket or a socket-outlet, see Figure 2 ( <i>Page 9</i> ). A plug will have 2 or 3-pins depending on whether the appliance fed from it has an earth connection or is double insulated.
Power supply cord	A flexible cord that is connected to an electrical appliance and has a plug for connection to a socket-outlet, see Figure 2 ( <i>Page 9</i> ).
Residual current device ( <i>RCD</i> ) used for personal protection	<p>A device that will protect you from receiving a fatal electric shock, if a fault to earth occurs in an electrical installation.</p> <p>The RCD must be Type A with a rated residual current of 30 milli-ampere (<i>mA</i>) and be either labelled as such or have the symbol  on the device.</p> <p>There are three common “functional” types of RCDs used for personal protection, being:</p> <p>(a) The type mounted on your switchboard for protection of lighting and socket-outlet wiring. Switchboard mounted types may also be referred to as an RCCB or RCBO: these types are a combined circuit-breaker and RCD. The circuit-breaker is identified by a toggle switch, while the RCD is usually identified by a test push button.</p> <p>(b) The type that forms part of a socket-outlet (<i>SRCD</i>) and has two push buttons mounted on the faceplate for the functional operation of the RCD (<i>these are located in a damp area such as a bathroom or garage</i>).</p> <p>(c) The portable type (<i>PRCD</i>), which also has two bush buttons mounted on the faceplate (<i>these are used with portable electrical appliances outdoors, e.g. hedge clippers, concrete mixers, lawn mowers, etc</i>).</p>

Residual current device ( <i>RCD</i> ) used for personal protection (cont'd)	RCDs will not protect you if the active and neutral wires are touched at the same time. This action is not safe and could cause a fatal electric shock.  RCDs are not to be confused with circuit-breakers, which are similar in appearance; circuit-breakers will not protect you from receiving an electric shock.
Resistance ( <i>Ohm</i> )	The opposition or resistance to current flow in an electrical circuit. The unit of resistance is the "Ohm" or " $\Omega$ ".
Socket	A fitting that attaches to a flexible cord and is designed to accept the pins of a plug, see Figure 2 ( <i>Page 9</i> ).
Socket-outlet	A fitting that forms part of the electrical installation and is designed to accept the pins of a plug, see Figure 2 ( <i>Page 9</i> ).
Voltage	The pressure of the electrical power supply. The unit of pressure of the electricity supply is the "Volt", or " <i>V</i> ". For example your household electricity is supplied at 230 V.
Wattage ( <i>power</i> )	The unit of power is the "Watt" and power is usually expressed as "Watts" or " <i>W</i> ". The appropriate power supply is marked on the nameplate, e.g. a heater may be labelled 2,300 W, a light bulb may be labelled 60 W.
Wires	Inner wires of any flexible cord.

## 1.3 BEFORE YOU START

- 1.3.1 Before you carry out any repairs on an electrical appliance, check that the appliance does not fall into the categories set out under subclause 1.1.5 (a) or (b). If repairs can be carried out on your appliance (*including its power supply cord*), or cord set, make sure they are disconnected from the power supply. Before carrying out any repairs to any extension lead make sure it has been disconnected from the power supply.



(See Figure 2, Page 9 for examples of a typical electrical appliance, cord set and extension lead).

- 1.3.2 Use a 3-wire flexible cord to connect earthed electrical appliances to the power supply.
- 1.3.3 Use a 2-wire flexible cord to connect double insulated electrical appliances to the power supply. If you use a 3-wire flexible cord, the green/yellow wire must be connected at the plug but must **NOT** be connected to any part of the double insulated appliance. The green/yellow wire must be cut back to the outer insulation of the flexible cord. Double insulated electrical appliances are marked with the symbol shown in Figure 1 on the nameplate or with the words “double insulated”.

**FIGURE 1: DOUBLE INSULATION SYMBOL**



- 1.3.4 The current rating of any flexible cord, plug, socket or appliance connector must be equal to, or greater than, the current rating of the electrical appliance to which it is connected.
  - 1.3.5 See Table 2 (Page 14) for the relationship of the minimum current rating of flexible cords to electrical appliance power rating (Watts).
- 1.4 **TOOLS**

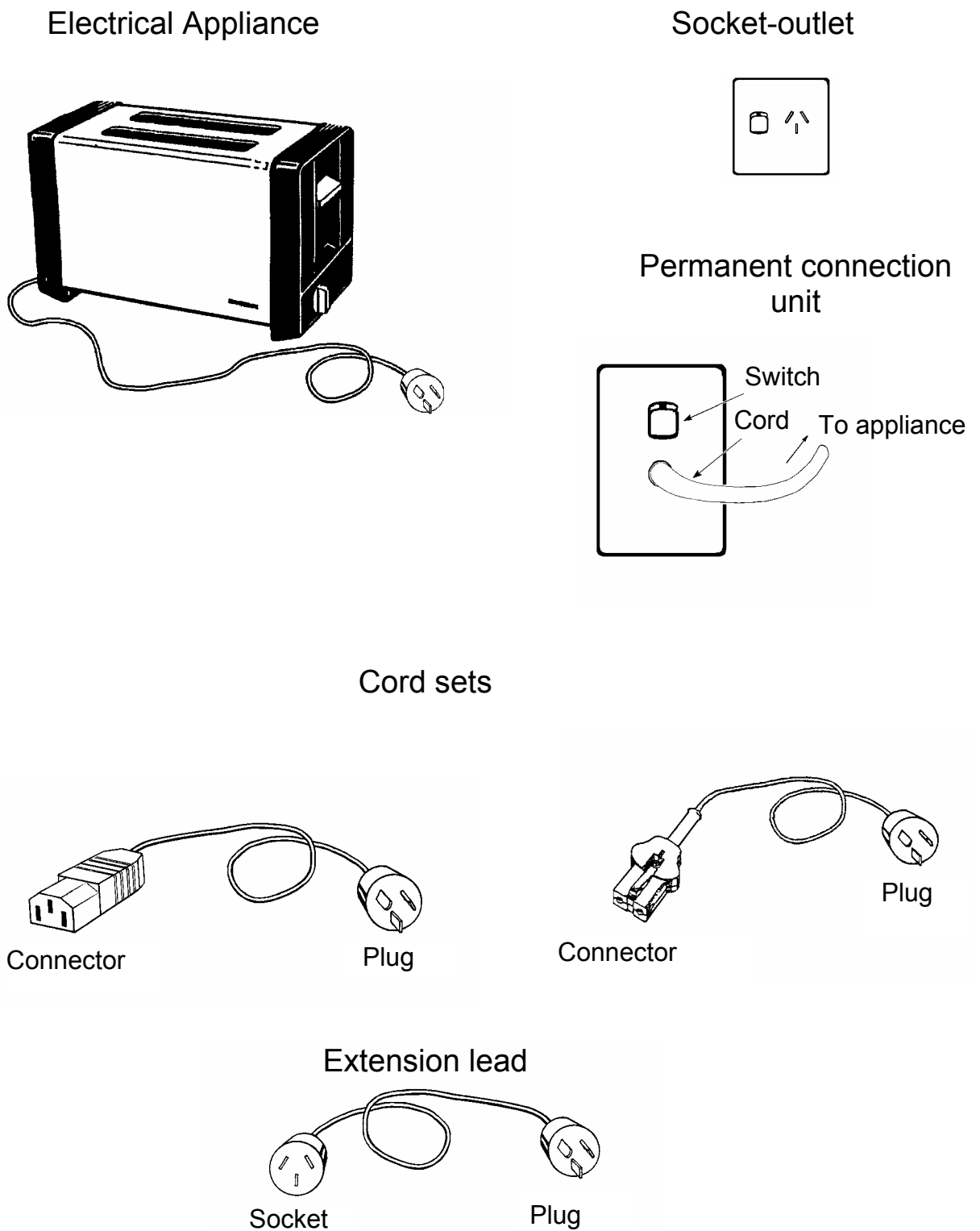
You'll need these tools for repairing electrical appliances and for wiring fittings to flexible cords:

- (a) A cutter for stripping wire (e.g. *wire strippers or pocket knife*).
- (b) A small pair of side-cutting pliers (*side-cutters*).
- (c) A small pair of pointed nose or needle nose pliers (*long nose pliers*).
- (d) Various types and sizes of screwdrivers, depending on the type of fitting.
- (e) A multi-meter for testing.

## 1.5 REPAIRS AND TESTING

- 1.5.1 Unplug electrical appliances from the power supply before you make any adjustments (*e.g. adjusting a thermostat*) to that appliance, during or after repairs. If your appliance is permanently connected, see subsection 4.3 (*page 31*).
- 1.5.2 You must test any repaired electrical appliance, cord set, or extension lead, before reconnection to the power supply. See sections 3 and 4 for testing electrical appliances, cord sets or extension leads.
- 1.5.3 If the electrical appliance, cord set, or extension lead is still faulty after you have worked on and tested it (*in accordance with sections 3 and 4*), take it to a licensed electrical worker to have it repaired.
- 1.5.4 For testing, you must use a multi-meter that measures AC voltage and DC resistance (*Ohms ( $\Omega$ ) range*). You should have this meter with you before you begin repairs. The minimum resistance range of the multi-meter must be between 0  $\Omega$  to 200,000  $\Omega$ .
- 1.5.5 Always check the correct operation of the multi-meter before commencing any tests:
- The resistance reading is checked by turning the meter to the  $\Omega$  range and then connecting the meter probes together, see Figure 13 (*Page 27*). The reading should be zero. If the meter can be adjusted, adjust it to read zero. **NOTE**, digital meters are self ranging.
  - The voltage reading is checked by turning the meter to the required voltage range (*250 V AC*) and then measuring the voltage at a socket-outlet. Turn the socket-outlet switch to the "OFF" position, push one probe into the neutral (*top right looking at the front of the socket-outlet*) or into the earth (*bottom*) slot, and push the other probe into the active (*top left*) slot. Turn the socket-outlet switch to the "ON" position. The reading at the meter should be in the range of 220 V - 240 V.

**FIGURE 2: ELECTRICAL APPLIANCE, SOCKET-OUTLET, PERMANENT CONNECTION UNIT, CORD SETS AND EXTENSION LEAD**



## 1.6 FOR YOUR OWN AND EVERYONE ELSE'S SAFETY

- 1.6.1 Never make joints in flexible cords.  
*Reason: To reduce the danger of making contact with live wires.*
- 1.6.2 Never repair plugs, sockets or appliance connectors. If they are damaged, replace with new ones.  
*Reason: To reduce the danger of making contact with live connections.*
- 1.6.3 Never fit 3-pin plugs to both ends of a flexible cord.  
*Reason: To reduce the danger of making contact with live plug pins. If one of the three pin plugs is connected to a socket-outlet, there is an increased risk of receiving a fatal electric shock from the pins of the other plug.*
- 1.6.4 Do not use any type of tape to repair flexible cords. Always replace damaged cords.  
*Reason: To reduce the danger of making contact with live wires.*
- 1.6.5 Do not use unsheathed flexible cords (the 'trurip', small flat type) as a replacement cord for electrical appliances, cords, extension leads.  
*Reason: To reduce the danger of making contact with live wires. These types of cords do not have two layers of insulation (i.e. they are not double insulated). Unsheathed flexible cords do not provide enough mechanical protection against making contact with live wires.*
- 1.6.6 Never earth double insulated electrical appliances.  
*Reason: To reduce the danger of being exposed to metal parts, which may become live through the earth wire. Double insulated electrical appliances have been designed so that they do not require earthing.*
- 1.6.7 Always replace a cartridge fuse with one of the same type. Check the failed cartridge fuse for the correct current rating and replace the cartridge fuse with like for like; see Figure 23 (Page 47).  
*Reason: To reduce the danger of the circuit wire overheating and causing a fire.*

1.6.8 Never use a larger size of fuse wire, or more than one strand of fuse wire, to repair a re-wireable fuse. Check the current rating of the fuse carrier and always replace fuses with like for like, i.e. 5, 10, 15, 20 or 30 A fuse wire.

*Reason: To reduce the danger of the circuit wire overheating and causing a fire.*

## Section 2: FLEXIBLE CORDS AND FITTINGS

### 2.1 CHOOSING THE RIGHT PARTS

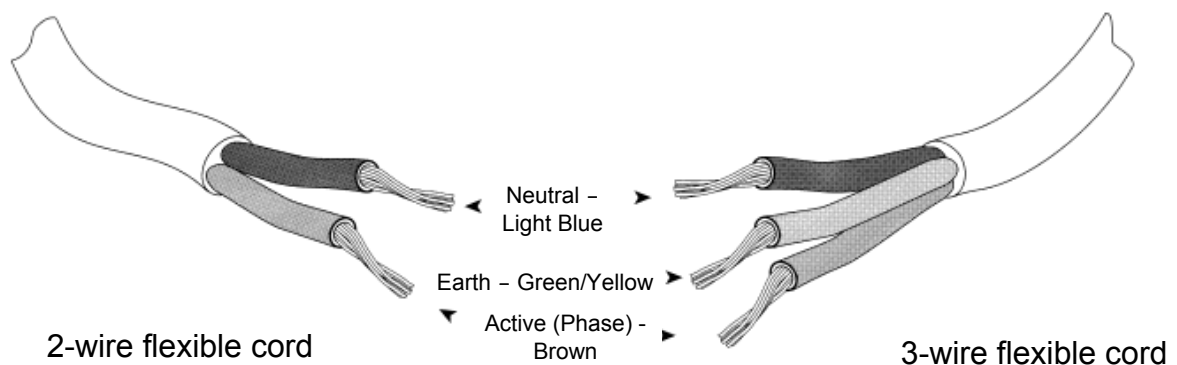
2.1.1 Choose flexible cords or plugs, sockets and appliance connectors (*fittings*) that are suitable for use in the environment in which you are going to use them. This includes damp situations and where fittings might suffer from rubbing or other physical damage, and for places where they may come in contact with high temperatures, such as in irons or toasters etc.

2.1.2 For the correct colour coding of new and old flexible cords, see Table 1 and Figures 3 and 3A.

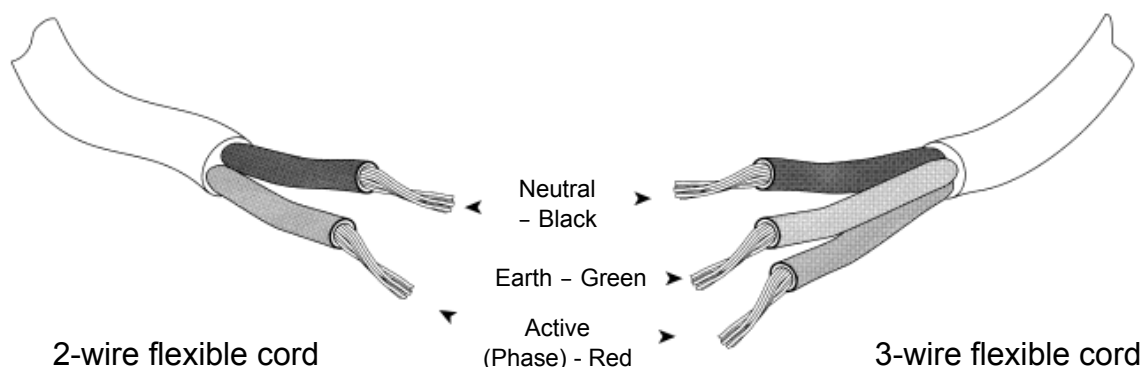
**TABLE 1: COLOUR CODING OF FLEXIBLE CORD WIRES**

Wire	Wire Colour Code (New)	Wire Colour Code (Old)	Terminal Marking
Active (Phase)	Brown	Red	A, P or L
Neutral	Light Blue	Black	N
Earth	Green/Yellow	Green	E

**FIGURE 3: TYPES AND COLOUR CODING OF WIRES FOR NEW FLEXIBLE CORDS**



**FIGURE 3A: TYPES AND COLOUR CODING OF OLDER FLEXIBLE CORDS**



## 2.2 CHOOSING THE RIGHT FLEXIBLE CORD

2.2.1 Before you replace any flexible cord, check the type of cord being used and most importantly measure its length. Flexible cords connected to electrical appliances have been designed to have a specific length. The replacement cord should be approximately the same wire size and length as the one you remove. Any flexible cord you use must be round (*i.e. like your finger*).

2.2.2 Choose flexible cords according to:

(a) The number of wires:

- (i) 2-wires; or
- (ii) 3-wires.

(b) The temperature rating of the cord. Cords are usually rated at 75°C or greater. Higher temperature cords of 85°C or greater rating are used for irons, heaters and toasters. Before replacing any cord, check the temperature rating that is marked on the sheath of the cord.

2.2.3 Flexible cords selected for electrical appliances must have:

- (a) An outer Tough Plastic Sheath (*TPS*); and/or
- (b) A temperature rating of 85°C or greater when used on heat producing appliances, such as toasters and irons; and
- (c) Inner coloured insulated wires; and

- (d) 3-wires (*active, neutral and earth*) for earthed appliances; or
- (e) 2-wires (*active and neutral*) for double insulated (*unearthed*) appliances; and
- (f) Approximately the same wire size and length as that being replaced.

2.2.4 When you choose the minimum size of wires for flexible cords, your choice must be based on the power (*W*) or current (*A*) rating of the electrical appliance to which you are going to attach the cord. See Table 2.

**TABLE 2: MINIMUM WIRE SIZE (FOR FLEXIBLE CORDS)**

<b>Current of Electrical Appliance (Amps or A)</b>	<b>Power Rating of Electrical Appliance (Watts or W)</b>	<b>Wire Size (mm<sup>2</sup>)</b>	<b>Number of Strands in Each Wire</b>
7.5 or less	1,725 or less	0.75	24
7.5 to 10	1,725 to 2,300	1.0	32
10 to 15	2,300 to 3,400	1.5	30
15 to 20	3,400 to 4,600	2.5	50

2.2.5 Flexible cords selected for cord sets and extension leads must have:

- (a) An outer tough plastic sheath (*TPS*); and
- (b) Inner coloured insulated wires; and
- (c) 3-wires (*active, neutral and earth*); and
- (d) A minimum wire size of 1 mm<sup>2</sup>.

2.2.6 Appliance cord sets should be approximately the same length of the one being replaced.

2.2.7 See Table 3 for the maximum length for an extension lead, and for the particular rating and wire size of the flexible cord.



**TABLE 3: MAXIMUM LENGTH OF FLEXIBLE CORD FOR EXTENSION LEADS**

<b>Extension Lead Current Rating (Amps or A)</b>	<b>Wire Size (mm<sup>2</sup>)</b>	<b>Number of Strands in Each Wire</b>	<b>Maximum Length of Flexible Cord* (m)</b>
10	1.0	32	10
	1.5	30	35
15	1.5	30	25
	2.5	50	40
20	2.5	50	30
	4.0	56	50

**\*NOTE:** If longer cords are used the appliance may not operate satisfactorily and safely.

### 2.3 CHOOSING THE RIGHT PLUG, SOCKET OR APPLIANCE CONNECTOR

Before replacing any plug, socket or appliance connector on a flexible cord, make sure that you have the correct one for the one you are going to replace. If you are replacing a plug, the plug should preferably have a section of the pins insulated. This new safety feature prevents accidental contact with the pins when unplugging from the socket-outlet.

**NOTE:** Most socket-outlets in domestic installations will only accept a 10 A plug with a maximum wattage of 2,300 W. Therefore, electrical appliances with wattages greater than 2,300 W can only be either fixed wired using a permanent connection unit or supplied by a higher rated socket-outlet, such as 15 or 20 A.

## Section 3: **HOW TO REPAIR ELECTRICAL APPLIANCE POWER SUPPLY CORDS, CORD SETS AND EXTENSION LEADS**

### 3.1 **SAFETY PROCEDURES**

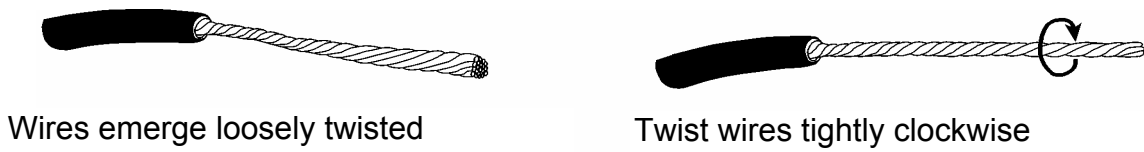
- 3.1.1 Unplug the electrical appliance power supply cord, cord set or extension lead from the electricity supply before starting work.
- 3.1.2 When you are carrying out repairs or maintenance on the electrical appliance power supply cord, cord set or extension lead:
  - (a) Remove damaged flexible cords or fittings. NEVER re-use damaged flexible cords or fittings; discard them.
  - (b) Choose the appropriate rated flexible cord and/or fitting.
  - (c) Follow the instructions for preparing the flexible cord in accordance with subsection 3.2.
  - (d) Follow the instructions for connecting the fitting to the flexible cord in accordance with subsection 3.3 or 3.4, and in accordance with the manufacturer's instructions.
- 3.1.3 If you are replacing the electrical appliance power supply cord, draw a diagram or label the connection terminals so you will know where to reconnect the wires.
- 3.1.4 Test your repaired power supply cord, cord set or extension lead before re-using it, see subsection 3.7.

### 3.2 **PREPARING A FLEXIBLE CORD**

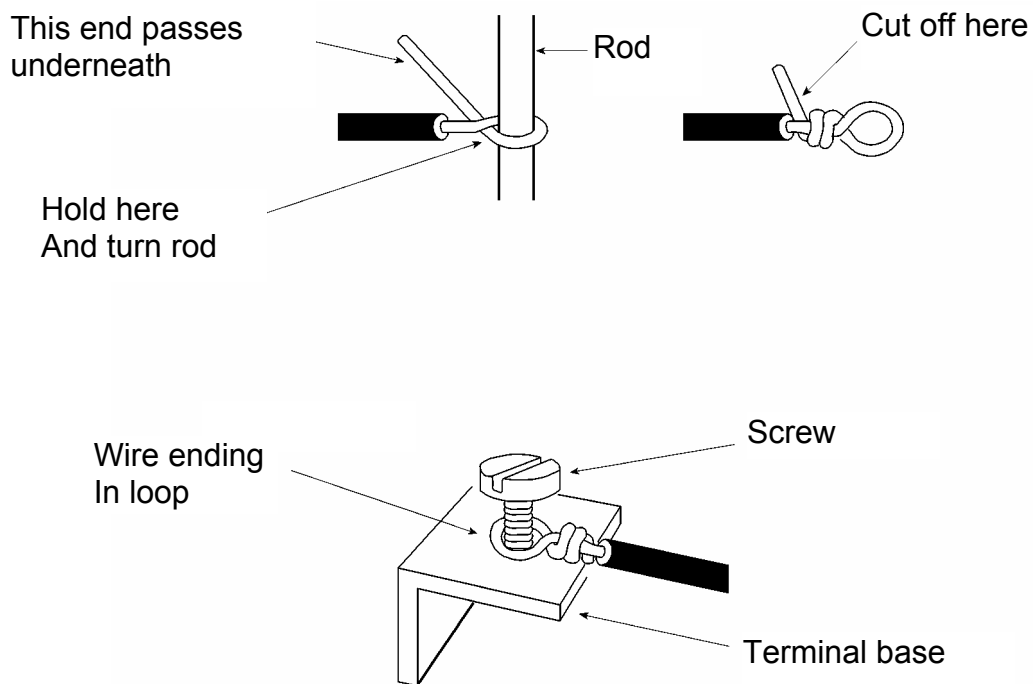
- 3.2.1 To prepare a flexible cord:
  - (a) Carefully remove the outer sheath, taking care not to cut (*nick*) the insulation on the wires or expose bare wires. The pocket knife or side cutters can be used for this task. If you accidentally cut the insulation, then cut off the damaged length and start the procedure again.
  - (b) Remove a sufficient amount of outer sheath, to enable the wires to reach the connections, while ensuring the outer sheath still covers the insulated wires under any cord clamping device.

- (c) Carefully strip approximately 20 mm of the coloured insulation from the wires, see Figure 4 (*Page 18*). The safest way of stripping back the insulation is to use wire strippers, since these can be set to accommodate the size of wires. The use of a pocket knife or side cutters, unless carefully used, is likely to damage the wires under the insulation. If you cut or damage any strands of wire, remove the damaged section and start again.
- (d) Twist each wire tightly with finger and thumb in the direction that they have been lightly twisted during manufacture (*usually clockwise*). The twisted wires are then ready for the formation of the loop, or double over as required by the particular connection.
- (e) If you are connecting the wire under the head of a screw, you will need to wrap the twisted wire around a suitable sized rod, screwdriver, or a nail to form a loop, no bigger than necessary, close to the insulation. The rod, screwdriver or nail is then turned one to one and a half times while the wire is held, see Figure 5 (*Page 18*). Twisting the rod, screwdriver or nail more than this will expose an unnecessary amount of bare wire. Excess wire is snipped off with side cutters, see Figure 5 (*Page 18*).
- (f) If you are connecting the wire into a screw terminal, you will need to form a double over end, where approximately 20 mm of insulation is stripped of the wires, and the strands are twisted as described in (d) above. The end of the wire is then doubled over with finger and thumb to form a rounded end, see Figure 6 (*Page 18*).

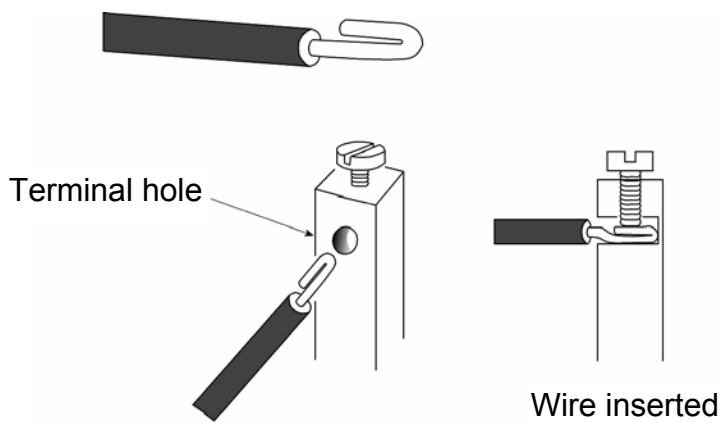
**FIGURE 4: WIRE WITH INSULATION REMOVED**



**FIGURE 5: WIRE WITH LOOP**



**FIGURE 6: WIRE DOUBLED OVER**



### 3.3 ATTACHING A 3-PIN PLUG OR SOCKET TO A FLEXIBLE CORD

- 3.3.1 To attach or replace a 3-pin plug or socket to a flexible cord:
- (a) Remove the cover on the 3-pin plug or socket, see Figures 7 and 9 (*Pages 20 and 21*) and, if necessary, slip the cover over the flexible cord. Check that the cover is on the cord the correct way round.

**NOTE:** The layout for connecting wires to each terminal, when looking from the back of the plug (*see Figure 8 Page 20*) or front of the socket (*see Figure 9*), is as follows:

- (i) The earth (*E*) terminal is at the bottom *centre* (*this always has the longest pin of a plug*); and
- (ii) Continuing in a clockwise direction the active (*A, P or L*) terminal; and
- (iii) Then the neutral (*N*) terminal.

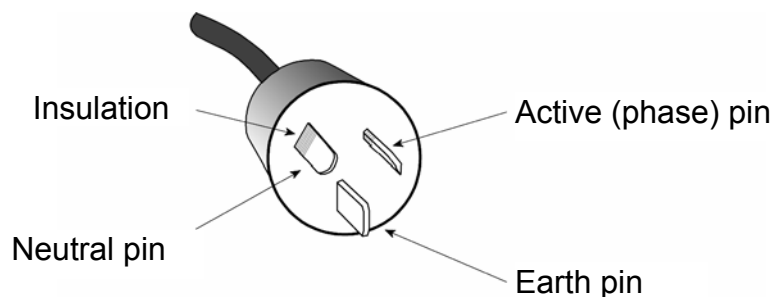
(*See Figures 8 and 10, Pages 20 and 21 for the correct terminal layout*).

- (b) Prepare the ends of the flexible cord, see subsection 3.2.
- (c) When the flexible cord has been prepared, spread the wires apart, and hold the cord wires up against an opened plug or socket. The path for each of the wires should be obvious to match each wire to the correct terminal. This can be done by making sure that the wires:
- (i) Avoid crossing any barriers inside the plug or socket; and
  - (ii) Avoid crossing over each other when connecting to the terminals.
- (d) Connect the wires to the correct terminals and tighten the screws. If the flexible cord contains an earth wire, connect the earth wire first (*green or green/ yellow*) and then the remaining wires.
- (e) Double check that:
- (i) The wires are connected to the correct terminals; and
  - (ii) All strands of wire are held by the terminals; if there are loose strands, these could accidentally come in contact with the other terminals, which would show up as a fault when tested; and
  - (iii) The insulation covers the wire all the way up to the terminal but is not held under the screw.

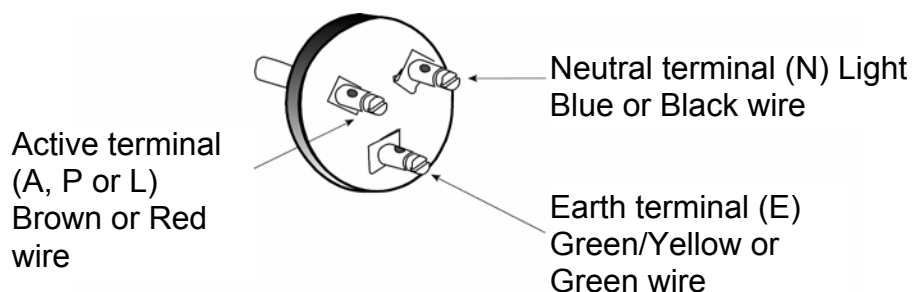
- 3.3.2 Place the cord anchorage over the sheath of the flexible cord and firmly tighten. With some plugs and sockets, the cord anchorage may be a tortuous path or form part of the cover attachment.
- 3.3.3 Place the cover on the plug and/or socket and tighten the cover retaining screw(s).
- 3.3.4 Use a multi-meter to test the continuity and polarity of the earth, active and neutral. The continuity test checks that the wires are continuous and not broken. The polarity test checks that the wires are connected to the right terminals, see Figures 13, 14 and 15 (*Pages 27, 28 and 29*).

**FIGURE 7: 3-PIN PLUG (FRONT VIEW)**

**NOTE:** Example of a 3-pin plug. There are many types, but all have the same terminal connections.

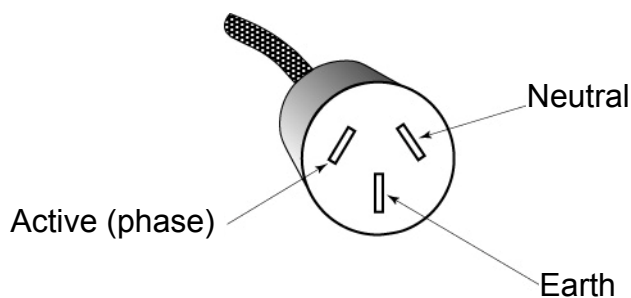


**FIGURE 8: 3-PIN PLUG WITH COVER REMOVED (BACK VIEW)**

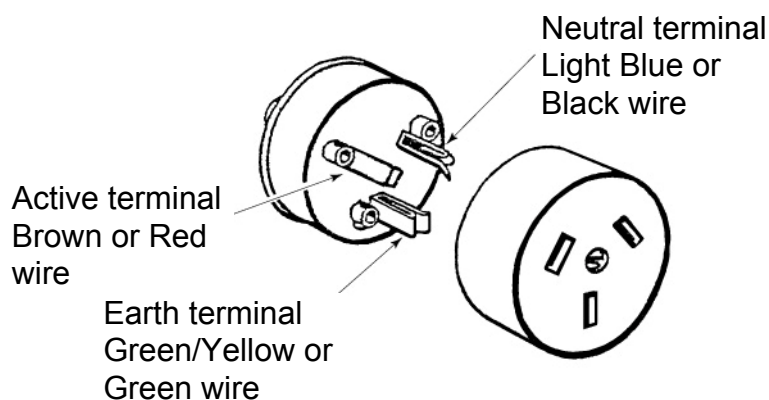


**FIGURE 9: 3-PIN SOCKET (FRONT VIEW)**

**NOTE:** Example of a 3-pin socket. There are many types, but all have the same terminal connections.



**FIGURE 10: 3-PIN SOCKET WITH COVER REMOVED (FRONT AND BACK VIEW)**



### 3.4 ATTACHING THE APPLIANCE CONNECTOR TO A FLEXIBLE CORD

3.4.1 Two types of appliance connector are common, see Figures 11 (*old type*) and 11A (*new type*), (*Page 24*).

(a) The old type is found on old metal type electric jugs and, in general, is only available for replacement for those cord sets.

- (b) The new type is used with electrical appliances that have a connector/appliance inlet system. You may find it difficult to buy these types of appliance connectors. Often it is more convenient and economical to buy a new flexible cord set with a “moulded on” appliance connector and 3-pin plug.

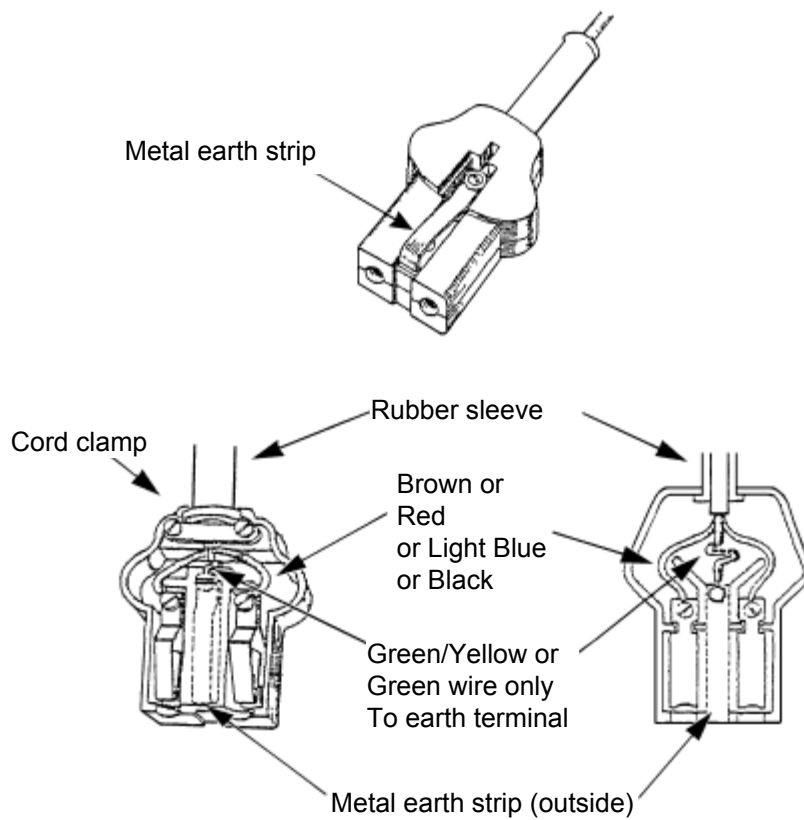
3.4.2 To attach an appliance connector to a flexible cord:

- (a) Remove the appliance connector cover and, if necessary, slip the appropriate parts over the cord. *(In general, these parts would be the strain relief/cord anchorage and cord protector.)*
- (b) Remove the appropriate amount of cord sheath and prepare loops or doubled over ends of the wire as described in subsection 3.2.
- (c) Connect the earth wire, green or green/yellow first. Make sure the wire is slightly longer than the active and neutral wires, so that if excess strain is applied to the flexible cord, the earth is the last to remain connected:
  - (i) For the old type connector, connect the green or green/yellow wire to the earthing strip terminal, see Figure 11 (Page 24).
  - (ii) For the new type connector, connect the green or green/yellow wire to the terminal marked E/X, see Figure 11A (Page 24).
- (d) Connect the red or brown wire to the terminal marked A, P or L. *(On the old type of connector there may not be a terminal marked A, P or L. In this case, the red or brown wire can be connected to either of the remaining terminals. Follow the pathway in the moulding if there is one.)*
- (e) Connect the black or blue wire to the terminal marked N. *(For the old type connector, connect the wire to the remaining terminal.)*
- (f) Double check that:
  - (i) The wires are connected to the correct terminals; and
  - (ii) There are no loose strands of wire at the terminals; and
  - (iii) The insulation covers the wire right up to the terminal but is not held under the terminal screw.
- (g) If there is a cord clamp, use it to secure the cord by the sheath so that the connections will not be strained if the cord is pulled.

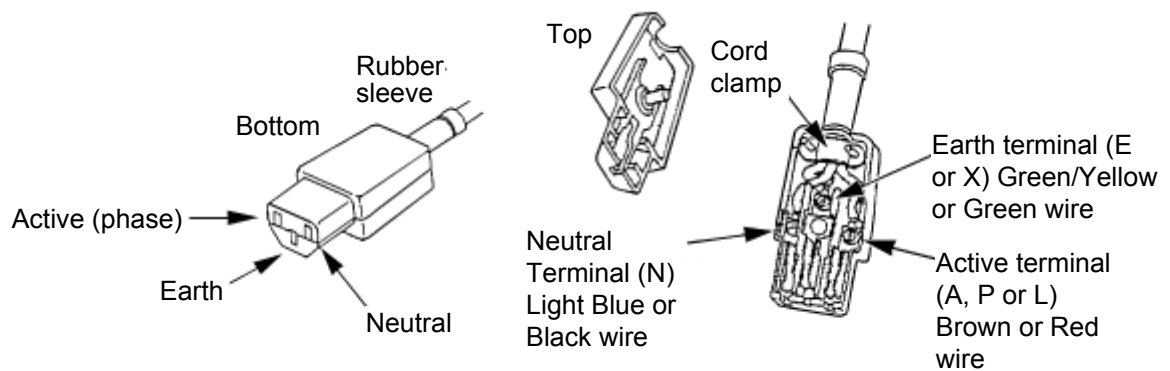


- (h) Reassemble the connector ensuring that all the parts covered by paragraph (a) are reinstated.
- (i) Test the continuity and polarity of the earth, active and neutral. The continuity test checks that the wires are continuous and not broken. The polarity test checks that the wires are connected to the correct terminals, see section 3.7 (*Pages 27 to 29*).

**FIGURE 11: APPLIANCE CONNECTOR (OLD)**



**FIGURE 11A: APPLIANCE CONNECTOR (NEW)**



### **3.5 SPECIFIC REQUIREMENTS FOR EXTENSION LEADS**

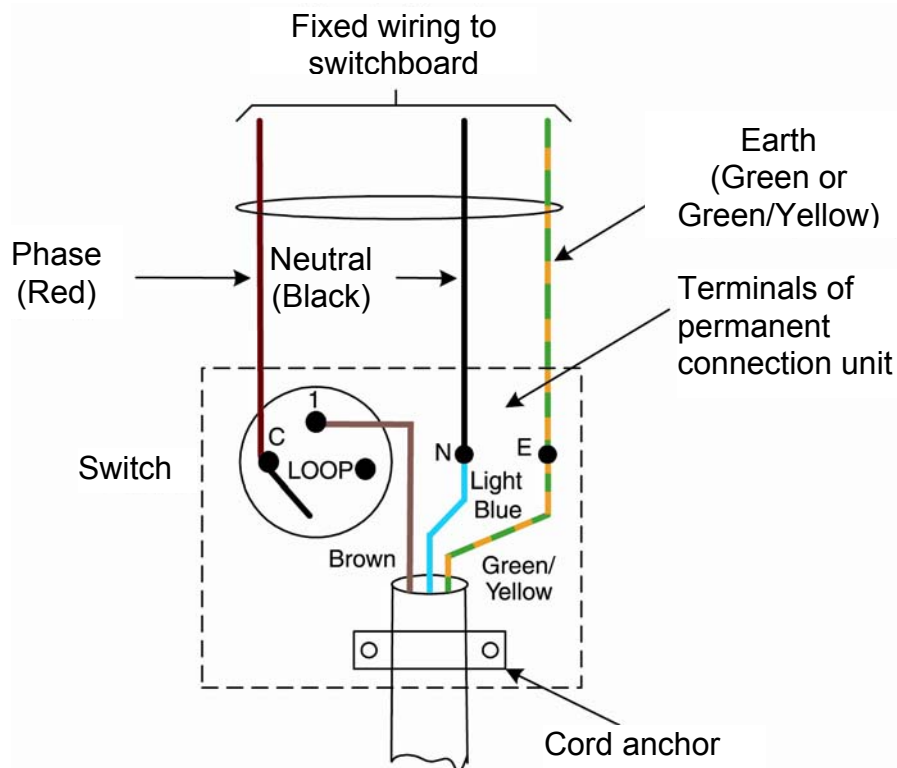
- 3.5.1 The flexible cord for extension leads must be the 3-core type (*with active, neutral, and earth wires*).
- 3.5.2 The wire size for the extension lead must be 1.0 mm<sup>2</sup> or larger. The maximum length for each wire size is given in Table 3 (*Page 15*).
- 3.5.3 Follow subsection 3.2 for preparing the ends of the flexible cord.
- 3.5.4 Follow subsection 3.3 for attaching the 3-pin plug and socket to the extension lead.
- 3.5.6 Test the completed lead in accordance with subsection 3.7.

### **3.6 REPLACING A POWER SUPPLY CORD ON AN ELECTRICAL APPLIANCE**

- 3.6.1 If your supply cord falls under subclause 1.1.5 (a) and/or (b), you cannot repair it.
- 3.6.2 To replace the power supply cord on an electrical appliance it must be repairable, under subclause 1.1.5 (c):
  - (a) Make sure you have unplugged the appliance from the power supply;
  - (b) Remove the cover of the appliance where the cord is connected;
  - (c) Undo the cord anchorage;
  - (d) Draw a diagram of how the connections are made and label the connection points of all the wires. This will ensure that when you reconnect, the connections will be the same as when you disconnected them;
  - (e) Remove the cord from the appliance;
  - (f) Ensure the cord replacement is approximately the same size and length as the one you removed;
  - (g) Follow subsection 3.2 for preparing the ends of the flexible cord;
  - (h) Follow subsection 3.3 for attaching the plug to the flexible cord;
  - (i) Reconnect the flexible cord on to the appliance.

- 3.6.3 Make sure:
- (a) The wires are connected to the correct terminals on the appliance; and
  - (b) There are no loose strands of wire at the terminals; and
  - (c) The cord anchorage has been reinstated on the appliance; and
  - (d) All covers previously removed are securely reinstated.
- 3.6.4 If the electrical appliance has a 3-pin plug connected, see subsection 3.3 for fitting the plug to the cord.
- 3.6.5 Test the power supply cord and 3-pin plug wiring as detailed in subsection 4.5.
- 3.6.6 If the cord is connected to a permanent connection unit (PCU), ensure that the power supply to the PCU has been disconnected, see subsection 4.3 for details. Remove the cord, remembering to make a drawing and/or mark the connections of the old cord, then replace the new cord connections to the same terminals as per your drawings/markings, see Figure 12.

**FIGURE 12: PERMANENT CONNECTION UNIT WIRING**



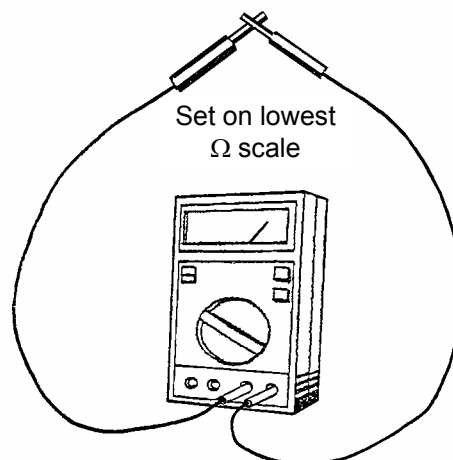
**NOTE** - Switch shown in "OFF" Position

## 3.7 TESTING CORDS AND EXTENSION LEADS

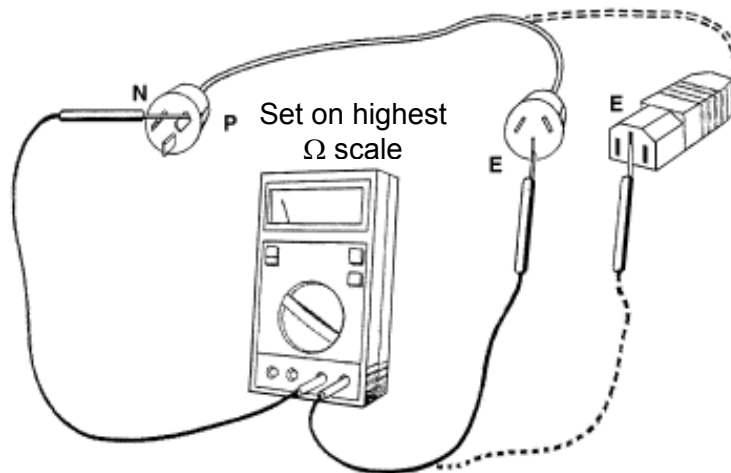
### Active/Neutral to Earth Test

- 3.7.1 Before beginning the test, switch the meter to the  $\Omega$  range and connect the probes of the meter together, see Figure 13. If the meter is adjustable, adjust it to read zero  $\Omega$  with the probes connected together.
- 3.7.2 Set the meter to the highest  $\Omega$  scale to carry out a active and neutral to earth test.
- 3.7.3 Connect one probe of the meter to the active (*phase*) and neutral pins of the plug and the other probe to the earth pin of the socket.
- 3.7.4 To pass the test, the needle or digital reading must indicate more than 200,000  $\Omega$  or 200 k $\Omega$ , see Figure 14 (*Page 28*). If the reading is zero, then it is likely that the active or neutral wire is touching the earth wire.
- 3.7.5 For electrical appliances with a cord set permanently connected to the appliance, and a metal exterior, connect the other probe to the metal exterior of the appliance, see Figure 20 (*Page 37*).

**FIGURE 13: METER CALIBRATION TEST**



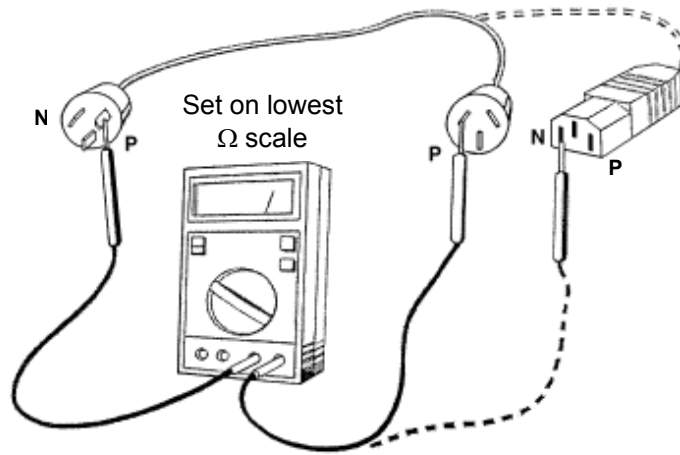
**FIGURE 14: ACTIVE/NEUTRAL TO EARTH TEST**



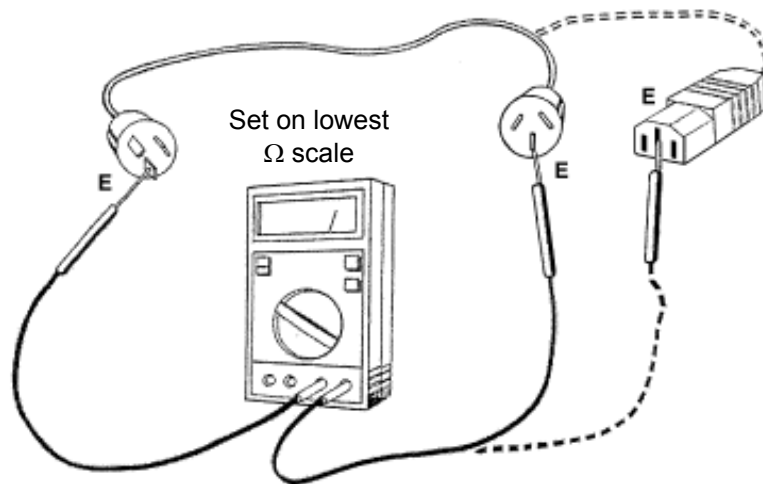
### **Active or Neutral and Earth Tests**

- 3.7.6 Carry out active or neutral and earth continuity tests by using the multi-meter set on the lowest  $\Omega$  scale.
- 3.7.7 Connect one probe of the meter to the active (*phase*) pin of the plug and the other probe to the active slot of the socket, see Figure 15 (*Page 29*). The neutral connection can be tested by connecting one probe to the neutral pin of the plug and the other probe to the neutral slot of the appliance connector.
- 3.7.8 Then connect one probe to the earth pin of the plug and the other probe to the earth slot of the socket, see Figure 16 (*Page 29*).
- 3.7.9 To pass the tests the needle or digital reading must indicate less than 1  $\Omega$ , see Figures 15 and 16 (*Page 29*). If there is no reading, then it is likely that the active, neutral or earth wire has been incorrectly connected at the plug or socket. This will need to be checked to ensure that you have the correct connections.

**FIGURE 15: ACTIVE OR NEUTRAL TEST**



**FIGURE 16: EARTH TEST**



## Section 4: **REPAIRING ELECTRICAL APPLIANCES**

### 4.1 **GENERAL**

- 4.1.1 Some electrical appliances have special screws to hold parts together. A special tool, which is only used by a manufacturer, is required to remove these screws. They are not intended to be removed by the owner of the appliance. Do not attempt to repair such appliances. Discard them or return them to the manufacturer.
- 4.1.2 Do not attempt to repair electrical appliances that require the repairs to be carried out by the manufacturer or a licensed electrical worker.
- 4.1.3 If your appliance falls under the category set out in subclause 1.1.5 (c), you may carry out repairs using this Code.
- 4.1.4 Before beginning any repairs, you must unplug the electrical appliance if it is connected to a socket-outlet. If it is connected to a permanent connection unit, follow the procedures of subsection 4.3. If left plugged in or connected, there is the possibility that the appliance could be accidentally switched on at the socket-outlet or the switch controlling the appliance.
- 4.1.5 After any repairs and before re-using the electrical appliance, you must test that appliance in accordance with either subsection 4.6 or 4.7, whichever applies.

### 4.2 **DOUBLE INSULATED ELECTRICAL APPLIANCES**

- 4.2.1 If the appliance is of the type specified under subclause 1.1.5 (c), you may carry out repairs using this Code.
- 4.2.2 The power supply cord on double insulated electrical appliances requires only 2-wires.
- 4.2.3 Double insulated electrical appliances are specially designed and don't require an earth connection, although there may be exposed metal parts. Double insulated electrical appliances are marked with the symbol shown in Figure 1 (*Page 7*).



- 4.2.4 For double insulated electrical appliances connected by a 2-wire flexible supply cord with a 3-pin plug, only the neutral (*N*) and active (*A* or *P*) pins of the plug are used. If a 3-wire flexible cord is used, the green/yellow wire must be connected at the plug but must **NOT** be connected to any part of the appliance. The green/yellow wire must be cut back to the same level as the outer insulation of the flexible cord.

### 4.3 **PERMANENTLY CONNECTED ELECTRICAL APPLIANCES**

- 4.3.1 Permanently connected electrical appliances are connected to the power supply by fixed wiring to a permanent connection unit; for a wiring diagram see Figure 12 (*Page 26*). Electrical appliances connected this way could include storage heaters, dishwashers and waste disposal units.

- 4.3.2 Switch off the power supply to the electrical appliance at the switchboard before attempting repairs.

- 4.3.3 If, on the switchboard, there is a marked fuse or circuit-breaker for the electrical appliance you want to work on, remove the fuse carrier or switch the circuit-breaker to the "OFF" position. Put the fuse carrier in a place that will prevent anyone else putting it back in place or place a piece of tape over the switch of the circuit-breaker to prevent it being turned on.

#### **OR**

- 4.3.4 If unsure, switch off the main switch or main circuit-breaker at the switchboard. Doing this will disconnect the power supply to the whole of the installation; it will require the resetting of any electrically powered digital clocks etc, when the power supply is turned back on.

- 4.3.5 When you have disconnected the power supply to the electrical appliance, test the circuit for the permanent connection unit to determine that the power supply has been disconnected. Use a multi-meter to do this.

- 4.3.6 First test the meter on a socket-outlet that is alive to ensure it is working by setting the meter to the 250 V AC or higher range. Then test between active and earth of the permanent connection unit, see Figure 12 (*Page 26*). If there is no

reading with the permanent connection unit switch on, the circuit will be disconnected. You can then begin to repair the appliance.

- 4.3.7 Draw a diagram of how the connections are made and label the connection points of all the wires. This will ensure that when you reconnect, the connections will be the same as when you disconnected them.

#### 4.4 REPAIRING ELECTRICAL APPLIANCES

- 4.4.1 First, check the operation of the electrical appliance by plugging it into a socket-outlet that you know to be working. If the appliance does not work, check the power supply cord, or plug and repair/replace if faulty. These repairs are carried out in accordance with section 3.
- 4.4.2 If the supply cord and plug are not faulty, the appliance will require repair. Find the faulty component (*i.e. broken element or faulty switch, etc*) and replace with a new component of the same size and/or type.
- 4.4.3 Before putting the repaired electrical appliance back together, look to make sure that:
- (a) Any component has been correctly reinstated;
  - (b) The appliance and plug are correctly wired;
  - (c) There is no damage to the case or power supply cord;
  - (d) Coloured wires are correctly located away from heat and physical damage inside the appliance (*e.g. heater/toaster etc*);
  - (e) Heat resistant sleeveings are placed back over the wires (*if they have been removed*).
- 4.4.4 Replace any faulty fuses located inside the electrical appliance with the identical type and current rating.
- 4.4.5 If you removed covers to carry out work, you must replace them securely so that there are no exposed live terminals, and so that no-one can touch coloured insulation of unsheathed wires.
- 4.4.6 Carry out all the appropriate tests listed in subsection 4.5. If satisfactory, the electrical appliance may be re-connected to the power supply.

## 4.5 TESTING

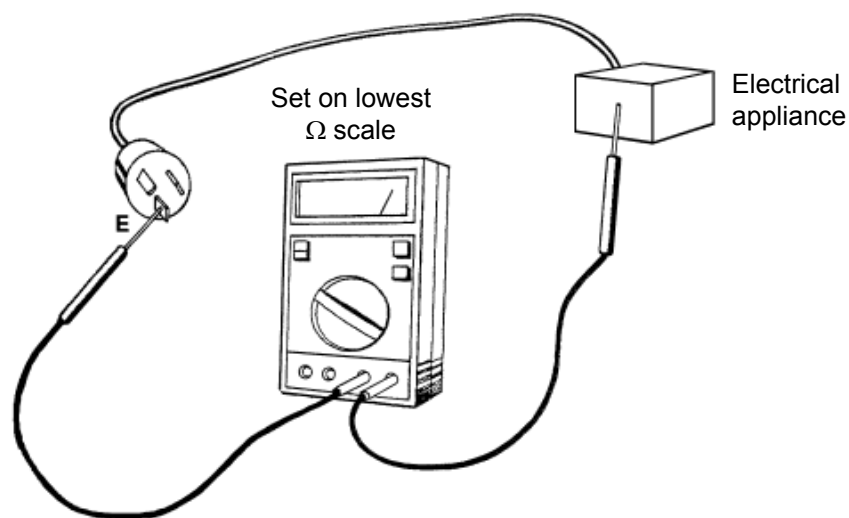
- 4.4.7 Before you reconnect any repaired electrical appliance to the power supply, you must test it to ensure that it is electrically safe.
- 4.4.8 Before beginning the test, check that the multi-meter works by switching the meter to the  $\Omega$  range and connect the probes of the meter together see Figure 13 (*Page 27*). If the meter is adjustable, adjust it to read zero  $\Omega$  with the probes connected together.
- 4.4.9 Check the appliance nameplate to make sure that the electrical appliance is either earthed (*Class I*) or double insulated (*Class II*).
- 4.4.10 If the electrical appliance is earthed, the appliance will need the exposed metal parts to be earthed and it must be tested by carrying out the instructions in subsection 4.6.
- 4.4.11 If the electrical appliance is double insulated, the appliance must **NOT** be earthed and must be tested by carrying out the instructions in subsection 4.7.

## 4.6 PROCEDURE FOR TESTING EARTHED ELECTRICAL APPLIANCES (CLASS I)

### Earth Test

- 4.6.1 Carry out an earth test by using a multi-meter set on the lowest  $\Omega$  scale.
- 4.6.2 Connect one probe of the multi-meter to the earth pin of the plug and the other probe to each piece of exposed metal on the electrical appliance, see Figure 17.
- 4.6.3 To pass the test, the needle or digital reading must indicate less than 1  $\Omega$ .

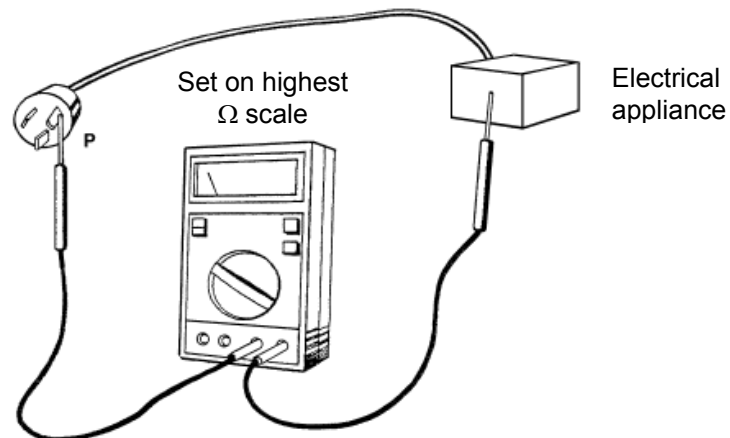
**FIGURE 17: EARTH TEST FOR ELECTRICAL APPLIANCES**



### Active to Earth Test

- 4.6.4 Carry out a active to earth test by using a multi-meter on the highest  $\Omega$  scale. If the electrical appliance has an on/off switch, move the switch to the “ON” position.
- 4.6.5 Connect one probe of the multi-meter to the active (*phase*) pin of the plug and the other probe to each piece of exposed metal on the electrical appliance, see Figure 18.
- 4.6.6 To pass the test, the needle of an analogue meter will not move or the reading will be greater than 200,000  $\Omega$ . For most digital meters, the reading will be 1 or M  $\Omega$ .

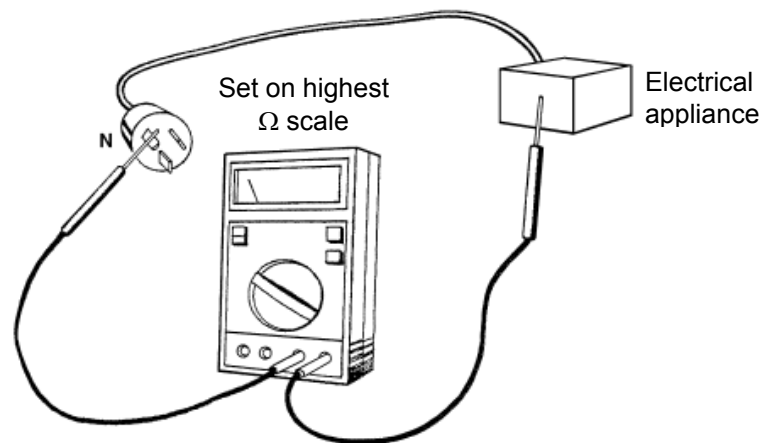
**FIGURE 18: ACTIVE TO EARTH TEST FOR ELECTRICAL APPLIANCES**



## Neutral to Earth Test

- 4.6.7 Carry out a neutral to earth test by using a multi-meter set on the highest  $\Omega$  scale.
- 4.6.8 Connect one probe of the multi-meter to the neutral pin of the plug and the other probe to each piece of exposed metal on the electrical appliance, see Figure 19.
- 4.6.9 To pass the test, the needle of an analogue meter will not move or the reading will be greater than 200,000  $\Omega$ . For most digital meters, the reading will be 1 or M  $\Omega$ .

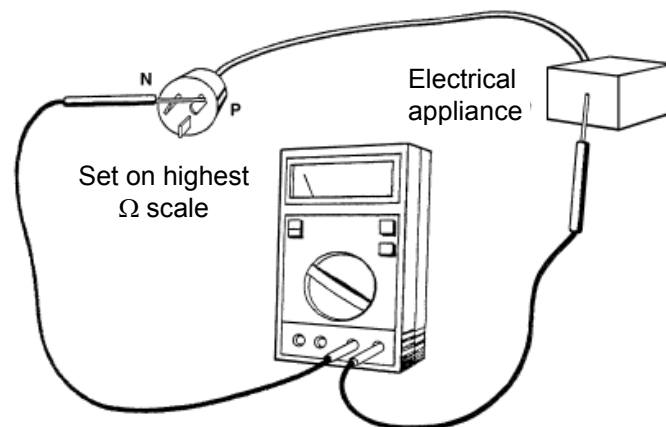
**FIGURE 19: NEUTRAL TO EARTH TEST FOR ELECTRICAL APPLIANCES**



## 4.7 PROCEDURE FOR TESTING DOUBLE INSULATED ELECTRICAL APPLIANCES (CLASS II)

- 4.7.1 Carry out a active to exposed metal test by using a multi-meter on the highest  $\Omega$  scale. If the electrical appliance has an on/off switch, move the switch to the “ON” position.
- 4.7.2 Connect one probe of the multi-meter to the active (*phase*) pin of the plug and the other probe to each piece of exposed metal on the electrical appliance. Repeat, connecting the first probe to the neutral pin of the plug and the second probe to each piece of exposed metal on the electrical appliance, see Figure 20.
- 4.7.3 To pass the test, the needle of an analogue meter will not move or the reading will be greater than 200,000  $\Omega$ . For most digital meters, the reading will be 1 or M  $\Omega$ .

**FIGURE 20: EXPOSED METAL TEST FOR DOUBLE INSULATED ELECTRICAL APPLIANCES**



## APPENDIX A: RCDs, FUSES AND CIRCUIT-BREAKERS

### A1 RESIDUAL CURRENT DEVICES (RCDs)

- A1.1 An RCD is a personal protection device that protects you from receiving a fatal electric shock. If a fault occurs, the RCD will turn off the power supply to the circuit(s) it controls.
- A1.2 RCD devices come in three types:
- (a) The type mounted on your switchboard. These are different from circuit-breakers, which are similar in appearance (*circuit-breakers will not protect you from receiving a severe or fatal electric shock*). An RCD will have an operating switch and a “test” button, while a circuit-breaker has only an operating switch.
  - (b) The type that forms part of a socket-outlet (*usually located in a damp area such as a bathroom or laundry*) will have a “test” and “reset” button.
  - (c) The portable type for use with portable electrical appliances outdoors, e.g. hedge clippers, etc. These also have a “test” and “reset” button.
- A1.3 It is very important, even where RCDs are being used, to ensure that you do **NOT** touch any bare wires or connections when you are carrying out repairs on the installation wiring or on any electrical appliance that is plugged in, unless the power supply has been disconnected.
- A1.4 From 1 January 2003, the Electricity Regulations require all new domestic electrical installations to have a number of RCDs mounted on the main switchboard of that installation. These will provide protection of all lighting and socket-outlet circuits of that installation.
- A1.5 All new circuits run from the main switchboard of an existing installation are also required to be RCD protected. This RCD may be mounted on the switchboard for lighting and socket-outlet circuits or at the first socket-outlet on the circuit.
- A1.6 Prior to 1 January 2003, domestic electrical installations may have had an RCD fitted in the bathroom or laundry, usually as a socket-outlet type.



- A1.7 A good time to check that your switchboard RCDs are working is at the beginning and end of daylight saving. This can be done by pressing the “test” button on the RCD. Remember this test disconnects the power and will require you to reset any electronic timers, etc.
- A1.8 All switchboard mounted RCDs include an operating switch. If the RCD is on, this will be indicated by the switch position at “ON” or “I”; if the RCD is off, this will be indicated by the switch position being at “OFF” or “O”; if in the mid-way position, the RCD has automatically turned off and has disconnected the power.
- A1.9 All socket-outlet type RCDs include an indicator lamp or indicator flag. These types of RCDs should be tested monthly. This can be done by operating an electrical appliance from the socket-outlet and pushing the test button on the RCD; this should cause the appliance to turn off.
- A1.10 Portable type RCDs include an indicator lamp or indicator flag. These types of RCD should be tested each time you use them. This can be done by operating the electrical appliance connected to the RCD; pushing the test button will turn the appliance off.
- A1.11 Always reset the RCD after testing. For the switchboard mounted types, reset the RCD by switching the operating switch from “OFF” or “O” to the “ON” or “I” position until a clicking sound is heard. For the socket-outlet and the portable types, press the “reset” button.
- A1.12 Never use an RCD if the “test” button fails to turn off (*test button does not extend*). Seek advice from a licensed electrical worker as the RCD may need replacing.

## **A2 FUSES AND CIRCUIT-BREAKERS**

- A2.1 Fuses or circuit-breakers prevent overloading of the electrical wiring of the installation. These are found on the main switchboard and on other switchboards of the installation. Fuses may also be found in electric ranges and can be found inside electronic appliances.

- A2.2 Fuses and circuit-breakers on switchboards are normally labelled (*below each fuse or circuit-breaker*) with the type of circuit they control, see Table 4.
- A2.3 The number of fuses and/or circuit-breakers on the main switchboard will depend on the number of circuits in the electrical installation. However, in general, there will be:
- (a) A least 2 lighting circuits;
  - (b) Any number of socket-outlet circuits; and
  - (c) Separate circuits for the electric range, water heater and supplies to garages or outbuildings.
- A2.4 If the switchboard is not marked to indicate the circuit, then check the marking on the fuse carrier. It will be marked with the current rating of the fuse in amperes (A), see Table 4.

**TABLE 4: CIRCUITS AND CURRENT RATINGS OF FUSES OR CIRCUIT-BREAKERS**

<b>Circuit</b>	<b>Example of Label</b>	<b>Current Rating (Amperes)</b>
Lighting	“LIGHT”	5 A or 10 A
Socket-outlets	“HTG” or “S-O” or “GPO” or “Power”	10 A, 15 A or 20 A
Night store heater	“Storage heater”	15 A or higher
Water heating	“W/H”	10 A or 15 A
Electric range	“RANGE”	30 A or 32 A
Separate oven	“Oven”	15 A
Hob	“Hob”	20 A
Garages or outbuildings	“SUB”	15 A to 32 A

- A2.5 In the event of an overload, the fuse will melt or the circuit-breaker will turn off the electrical supply to that circuit. This prevents damage to the circuit wiring of the installation.

- A2.6 If the fuse blows again after you have repaired it or the circuit-breaker continues to turn off, the fault will need to be identified. This could be due to:
- (a) Overloaded circuit, i.e. too many electrical appliances operating at the same time from a socket-outlet(s);
  - (b) Faulty or damaged switch or socket-outlet;
  - (c) Faulty electrical appliance;
  - (d) Faulty light fitting, or blown light bulb;
  - (e) Damaged or faulty wiring in the installation.
- A2.7 Depending on the fault that you have identified, take further action as follows:
- (a) To prevent overloading a circuit, disconnect some of the electrical appliances; or
  - (b) If there are faulty or damaged switches or socket-outlets, replace with new. Carry out this work in accordance with ECP 51 or contact a licensed electrical worker; or
  - (c) Disconnect all electrical appliances that have stopped operating, repair the fuse or switch the circuit-breaker to the on position, and reconnect the electrical appliances one at a time. The electrical appliance that causes the fuse to blow or circuit-breaker to turn off is faulty and will require repair.
  - (d) If a light bulb has blown, replace bulb. If the light fitting is faulty, contact a licensed electrical worker.
  - (e) If there is damaged or faulty wiring, contact a licensed electrical worker.
- A2.8 There are two general types of fuses used in electrical installations, the cartridge fuse (*also known as HRC – high rupturing capacity*) and the re-wireable fuse, see Figure 21 (*Page 43*) for fuse types. See also Figure 22 (*Page 44*) for other types of re-wireable fuses.
- A2.9 The cartridge fuse is an insulating tube fitted with metal caps at each end and contains a fuse wire surrounded by insulating powder. This is held inside a specially designed carrier that plugs into a base.
- (a) **Never** attempt repairs to a cartridge fuse.
  - (b) **Always** replace the cartridge fuse with a new one of the same type, current rating and physical size.
  - (c) **Never** attempt to bridge a break in the cartridge fuse or holder in any way.

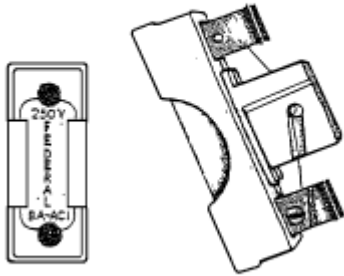
- A2.10 Re-wireable fuses are the type most often found in older domestic installations. They are made of a porcelain or bakelite base and have a fuse carrier containing the replaceable fuse wire. For replacement, ensure that a single strand of the same current rating fuse wire is used.
- A2.11 If any fuse base or carrier is damaged, cracked or broken, or is showing signs of heating or burning, the base and carrier will need to be replaced by a licensed electrical worker.

### **Circuit-Breakers**

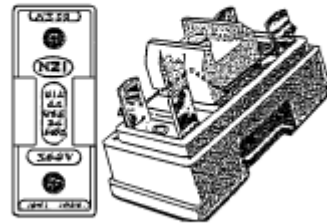
- A2.12 Circuit-breakers do the same thing as fuses. The types of circuit-breakers most commonly found on switchboards are the on/off push button and the on/off switch types.
- A2.13 To reset on/off push button types, simply push the button that has popped out, back in.
- A2.14 Some switch on/off types, when tripped (*automatically turned off*) by a fault, will move to the mid-point between “ON” and “OFF”. They need to be reset by switching them to “OFF” before turning back to “ON”. It is important to identify where the “ON” and “OFF” positions are. Some may have the “ON” position pointing up while others could be pointing down. The circuit-breaker will be marked “ON” or “OFF” or be marked “I” for “ON” and “O” for “OFF”.

## FIGURE 21: TYPES OF FUSES

### Re-wireable Fuses



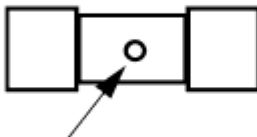
Federal fuse



NZI fuse

### Cartridge Fuses

#### Pull-cap fuse



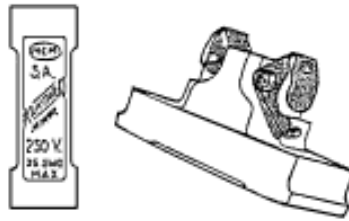
If black, it usually indicates the fuse has blown

#### Knife-blade fuse.

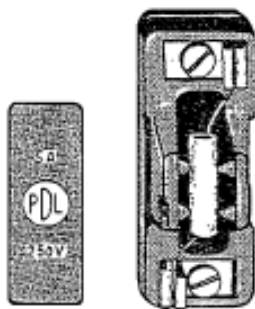
Rarely found in domestic installations. If used, it would be for the main fuse



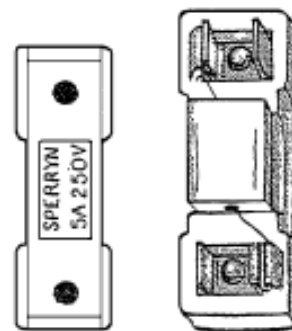
**FIGURE 22: OTHER TYPES OF RE-WIREABLE FUSES**



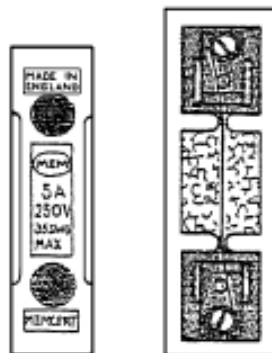
Kantark fuse



PDL fuse



Sperryn fuse



MEM fuse

## **A3 REPLACING OR REPAIRING A RUPTURED OR BLOWN FUSE**

### **To find out which fuse has ruptured or blown:**

- A3.1 Unplug any suspected electrical appliance that may be overloading the circuit or is faulty, check for any faulty switches or socket-outlets or turn light switches to the “OFF” position in case the light bulb has blown. For permanently connected electrical appliances, turn the permanent connection unit (*PCU*) switch to the “OFF” position.
- A3.2 For added safety, turn the “MAIN SWITCH” on the switchboard to the “OFF” position. This will prevent you coming into contact with live parts when removing fuse carriers.
- A3.3 Remove the fuse carriers by grasping them between thumb and finger. Then:
- (a) For a re-wireable fuse, examine each fuse carrier until you find the blown fuse.
  - (b) For a cartridge fuse, check to see if the indicator has turned black, see Figure 21 (*Page 43*) or check by using a multi-meter set on the  $\Omega$  scale. See subclause A4 for testing a cartridge fuse.
- A3.4 You will need the following items for repairing a blown, re-wireable fuse:
- (a) Correct amperage fuse wire, usually sold on labelled cards of different current ratings, i.e. 5, 10, 15, 20 and 30 A;
  - (b) A pair of scissors or small side cutters;
  - (c) A multi-meter (*optional*).
- A3.5 You will need these items for replacing a ruptured cartridge fuse:
- (a) New cartridges of the same type and rating;
  - (b) A multi-meter.

### **Replacing the blown fuse wire**

- A3.6 Remove any fuse wire from the blown fuse or any melted bits of wire.

- A3.7 Make sure that the fuse wire pathway where you are going to place the new fuse wire is clean.
- A3.8 Select the correct current rating of fuse wire. **Never** use more than one strand of fuse wire or a larger size fuse wire than is indicated on the carrier, or you could create a fire hazard.
- A3.9 Thread the fuse wire through the pathway in the fuse carrier and connect the ends at the terminals.
- A3.10 Trim the fuse wire so that no ends of the wire project out of the fuse carrier.
- A3.11 Place the fuse carrier back into its associated base.
- A3.12 Before turning on the main switch, **make sure your face is turned away from the fuse**. If the fuse blows again a hazard could be created.

#### **Replacing the ruptured cartridge fuse:**

- A3.13 Select the correct size cartridge. Ensure the replacement cartridge is of the same type, current rating and physical size. **Always** use cartridge fuses in this type of fuse carrier.
- A3.14 Place the cartridge into the fuse carrier.
- A3.15 Place the fuse carrier back into its associated base.
- A3.16 Turn on the main switch. If the fuse ruptures again it is unlikely that any hazard would be created, unlike the re-wireable fuse.

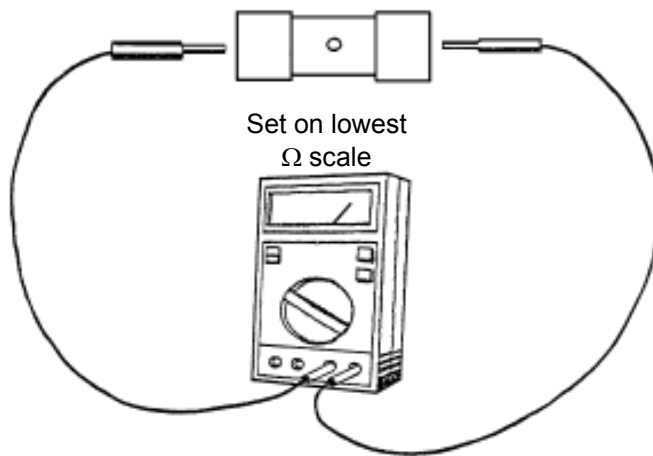
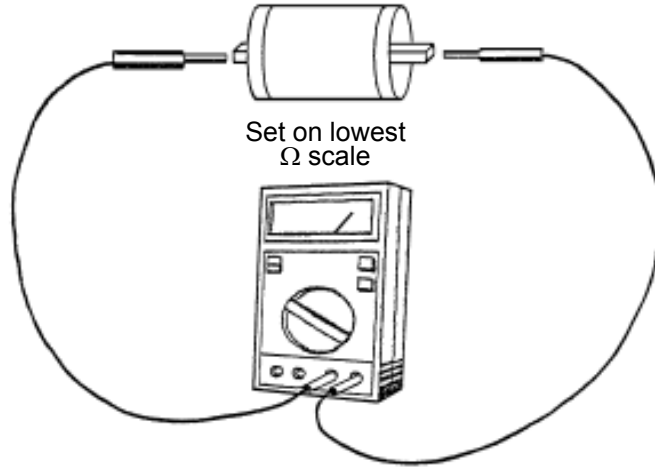
### **A4 PROCEDURE FOR TESTING CARTRIDGE FUSES**

- A4.1 Remove cartridge fuse.
- A4.2 Carry out a test on the cartridge fuse by using a multi-meter on the lowest  $\Omega$  scale, see Figure 23 (*Page 47*).
- A4.3 Connect one probe to one end of the fuse and the other probe to the other end. Make sure they make good contact with the metal.
- A4.4 If the fuse has ruptured, there will be no reading.



## FIGURE 23: TESTING CARTRIDGE FUSES

**NOTE:** Meter readings show fuse is satisfactory



## A5 REPLACING RE-WIREABLE FUSES WITH PLUG-IN CIRCUIT-BREAKERS

- A5.1 Plug in circuit-breakers offer a simple way to assist in preventing a switchboard overload. You can replace re-wireable fuses with plug-in circuit-breakers, as long as the fuse base:
- (a) Is not damaged, cracked or broken; and
  - (b) Is not showing signs of heating or burning; and
  - (c) Can hold the plug-in circuit-breaker without exposing live contacts.
- A5.2 If the base needs to be replaced, contact or arrange with a licensed electrical worker to do this work.
- A5.3 **Always** check the fuse size and match it up with the correct size circuit-breaker.
- A5.4 **Do not** remove all the fuse carriers at once. Replace them individually so you can make sure you are putting in the right sized circuit-breaker. See Table 5, for the correct fuse/circuit-breaker match.

**TABLE 5: FUSE/CIRCUIT-BREAKER SIZES**

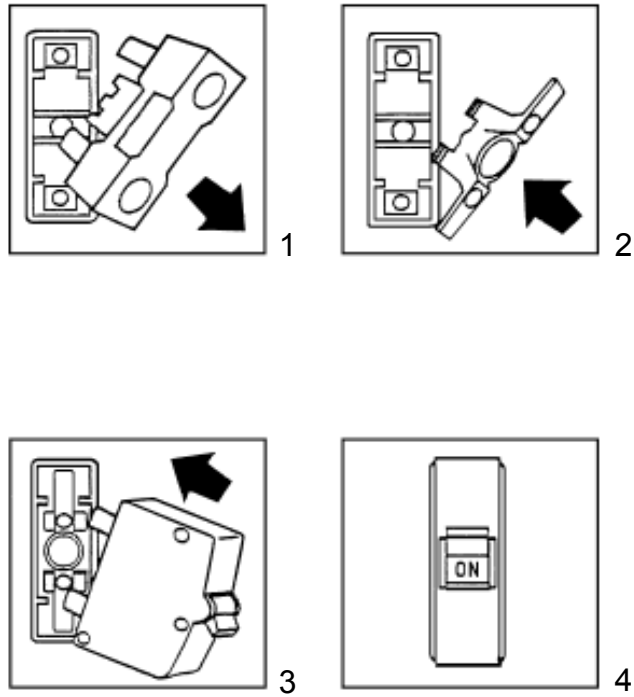
Fuse (A)	Circuit-breaker (A)
5	6
10	10
15	16
20	20
30	25, 32

- A5.5 The electric range fuse (*30 A re-wireable fuse*) has a large base and can't be replaced with a plug-in circuit-breaker. However, if you want to have the re-wireable fuse replaced with a circuit-breaker, get a licensed electrical worker to fit a circuit-breaker on your switchboard.

## To replace the fuse carrier with a plug-in circuit-breaker

- A5.6 Turn the main switch to the “**OFF**” position on the switchboard on which the re-wireable fuse is to be replaced by the circuit-breaker. Verify this by turning a light switch “ON” in your home (*the light should not work*).
- A5.7 Remove the fuse carriers one at a time, see Figure 24(1) (*Page 50*).
- A5.8 Check that the fuse base is suitable for fitting the plug-in circuit-breaker by inserting the circuit-breaker into the fuse base. The circuit-breaker should be firmly retained and there should be no exposed (*bare*) metal contacts visible when the circuit-breaker is fitted. If there are no exposed metal contacts, remove the plug-in circuit-breaker and proceed to the next step (*A5.10*).
- A5.9 Where the plug-in circuit-breaker is **NOT** firmly retained or if there are exposed metal contacts, the fuse base must be changed. Get a licensed electrical worker to fit a permanently wired circuit-breaker or fit a correct fuse base for the plug-in circuit-breaker.
- A5.10 Place the plastic insert (*which is provided with the plug-in circuit-breaker*) over the contacts of the fuse base, see Figure 24(2) (*Page 50*).
- A5.11 Make sure the circuit-breaker is in the “OFF” position.
- A5.12 Insert the circuit-breaker, making sure it is the correct amperage, see Figure 24(3) (*Page 50*).
- A5.13 Repeat steps from A5.7 – A5.12 for all fuses being replaced.
- A5.14 Restore the main switch at the completion of work and make arrangements with a licensed electrical worker to replace unsuitable fuse bases.
- A5.15 Turn each circuit-breaker to the “ON” position. This will be in the up position, see Figure 24(4) (*Page 50*).
- A5.16 Check that all lights and socket-outlets are working.

**FIGURE 24: REPLACEMENT OF FUSES WITH PLUG-IN CIRCUIT-BREAKERS**



## **APPENDIX B: ELECTRICAL SAFETY CHECKS**

**Check the back pages of your Yellow Pages for information on first aid.**

### **B1 STAY SAFE**

- B1.1 Always remember that electric voltages and currents can be dangerous. Unplug, disconnect or isolate any electrical appliance, cord set or extension lead before attempting any inspection, replacement or repair of any appliance, cord or extension lead.
- B1.2 Replace any broken or damaged fittings.
- B1.3 Never replace a blown fuse wire with a larger size fuse wire.
- B1.4 Always turn the power supply off if painting or wallpapering around switches or socket-outlets or other fittings.
- B1.5 Contact your electricity retailer (obtain contact details from your power account) to disconnect the power supply if working or painting near overhead electric lines.
- B1.6 Never erect radio and TV aerials near overhead electric lines.
- B1.7 Never erect boat masts near overhead electric lines. Also watch out for overhead electric lines when moving boats onshore or close to shore. Always look up and check.
- B1.8 Beware of overhead electric lines when installing wire fences.
- B1.9 Never fly kites near overhead electric lines.

### **B2 SOCKET-OUTLETS**

- B2.1 Never overload socket-outlets. Socket-outlets are designed to take one or two electrical appliances, (*the total current rating of a double socket-outlet is 10 A*).
- B2.2 Never allow children to play with socket-outlets. Make your socket-outlets safe by inserting safety caps. Some modern socket-outlets usually have in-built safety shutters that only open when the pins of a plug are pushed into the shutter.

- B2.3 If there are not enough socket-outlets in the installation and you use a socket-outlet multi-box, make sure that it has a circuit-breaker mounted in it. **WARNING:** The total amount of load or electrical appliances that can be connected to a multi-box must be limited to the recommendations on the multi-box. Multi-boxes are not suitable for refrigerators, freezers, toasters, kettles, heaters, washing machines or dryers. Overloading with these electrical appliances will result in the multi-box contacts failing and this could cause a fire. Also ensure that the multi-box is not left on the floor; mount it on the wall.

### **B3 HEATING APPLIANCES**

- B3.1 Never have your water heater thermostat set too high. About 65-70°C is acceptable.
- B3.2 Never place heating appliances near curtains or bedding or clothing.
- B3.3 Never place clothes on top of heaters for drying purposes. Always use a drying rack at least 1 metre away from the heater.
- B3.4 Never place a heating appliance in a closed room. Always leave a door or window partly open.

### **B4 LIGHT FITTINGS**

- B4.1 Where a maximum wattage lightbulb is indicated, do not exceed this wattage; or else use a smaller wattage lightbulb.
- B4.2 Ensure that drapes and furnishing are kept clear of light fittings.

### **B5 RCDs**

- B5.1 Always plug a portable residual current device directly into the socket-outlet and test the RCD tripping, reset the RCD and then plug in the flexible cord into the RCD. Doing this protects you from a fault in the cord as well as the electrical appliance.

- B5.2 Test socket-outlet RCDs on a regular basis. Monthly testing is recommended. Press the test button on the RCD. The operational status will be indicated by the RCD operating toggle position, an indicator lamp or indicator flag.
- B5.3 Always reset the RCD after testing. Reset the RCD by switching the operating toggle from “OFF” or “O” to the “ON” or “I” position until a clicking sound is heard.
- B5.4 Never use an RCD if the test button fails to trip (*test button does not extend*). Seek advice from a licensed electrical worker as the RCD may need replacing.
- B5.5 If an RCD repeatedly trips, disconnect all the electrical appliances connected to the RCD, reset the RCD and reconnect the appliances **one at a time** until the appliance trips the RCD. This indicates that the last appliance connected is faulty and should be repaired before re-use. If the circuit includes a computer, the computer may cause a trip due to the inherent leakage of current associated with these appliances. Seek advice from a licensed electrical worker if required.
- B5.6 Occasionally, an electrical appliance may test “clear” when connected to an RCD on its own but may cause the RCD to trip when connected with a second appliance that has also tested clear. The cause of this may be that the leakage current of both, when added together, exceeds the RCD’s trip setting. In this case seek advice from a licensed electrical worker.

## **B6 ELECTRICAL APPLIANCES**

- B6.1 Replace any frayed or damaged cords on electrical appliances; do not tape them up.
- B6.2 Never take electrical appliances into a bathroom when they are supplied with electricity from another room.
- B6.3 Never use electrical appliances outdoors unless they are protected by an isolating transformer or by a residual current device.
- B6.4 Always switch off an electrical appliance before unplugging it.

- B6.5 Always unplug or disconnect electrical appliances before undertaking any repairs.
- B6.6 Never use a repaired electrical appliance or second hand appliance unless it has been tested.
- B6.7 Never leave electrical appliances unattended around swimming pools.